



**Welcome**

# **Civil Engineering – Tunnel Construction**

**FURRER Thomas**  
**Product Manager Plastic Welding**

Copyright by Leister 2011



**LEISTER**

# Scope



# Civil Engineering

## Tunnel construction - drilling and blasting technologies



→ Sealing inside

# Civil Engineering

Tunnel construction open mining technologies



→ sealing outside



# Civil Engineering

## Landfil (to store toxic materials)



# Civil Engineering

## Landfil (Goldmine)



**GOLD MINE, SAUDIA ARABIA**

**MATERIAL: HDPE 1.50 mm<sup>2</sup> QUANTITY : 600,000 M<sup>2</sup>**



# Civil Engineering

## Artificial lakes and rivers



# Civil Engineering

## Park and gardening





# Civil Engineering

## Sealing of dams (Colombia 2002)



# Civil Engineering

## Sealing of buildings

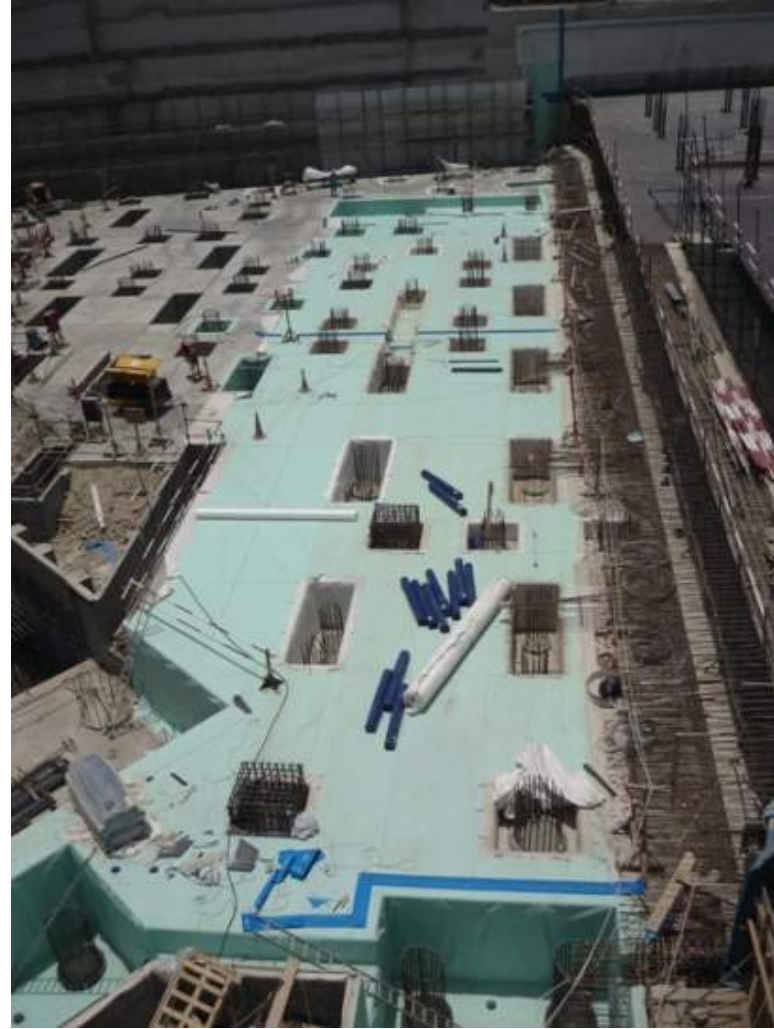

# Civil Engineering



Secondary containment for ground water protection



# Anwendungen



Secondary containment under oil tanks  
(Venezuela, 2009)





皮划艇激流回旋  
Canoe/Kayak-Slalom

# 皮划艇激流回旋赛道照片

Watersport, Olympia, China 2008



GSE公司**0.75毫米**厚  
HDPE土工膜，幅宽**7米**  
采用**TWINNY S**焊接机  
垂直爬行焊接，双轨焊  
缝质量完美无缺。



北京飞色塑料铆焊技术有限责任公司

Tel: 010-68230516

<http://www.refeng.cn>

**feise**  
飞色塑料铆焊



**LEISTER**

# Welding Procedure

- Hot air welding
- Extrusions welding
- Hot wedge welding (element)
- Hot air welding





# Welding Procedure

**Following welding procedures are possible:**

- Extrusion welding
- Hot wedge welding (element)
- Hot air welding

**All welding procedures require an accordance of the following parameters:**

- Temperature
- Pressure
- Speed

# “Hot Air” Welding Procedures

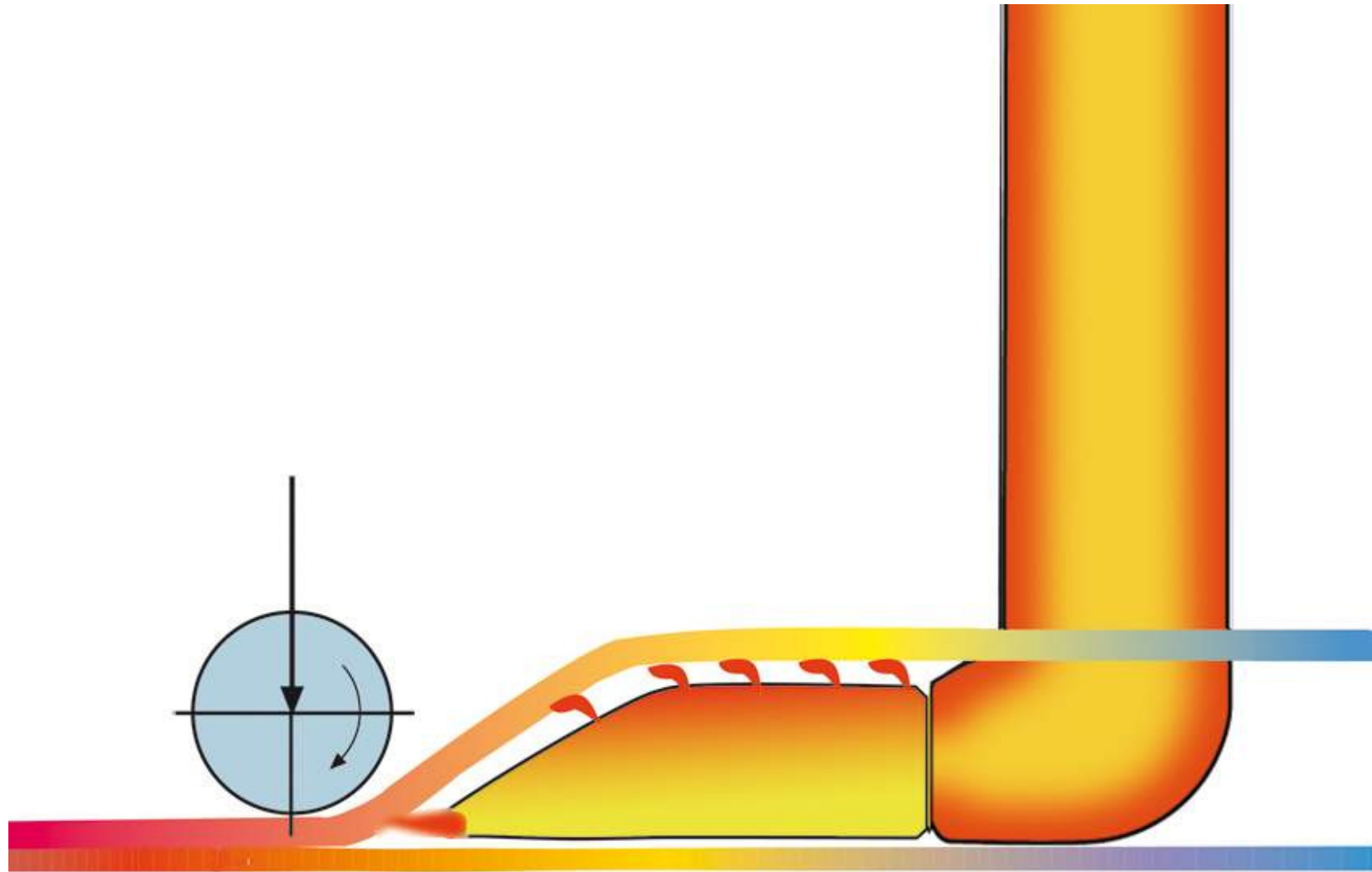

# “Hot Air” Welding Procedures





# Most common welding machines

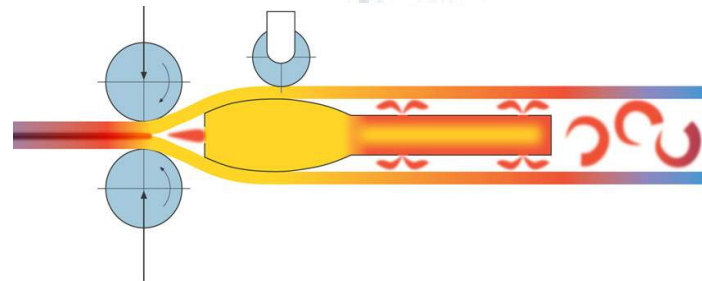
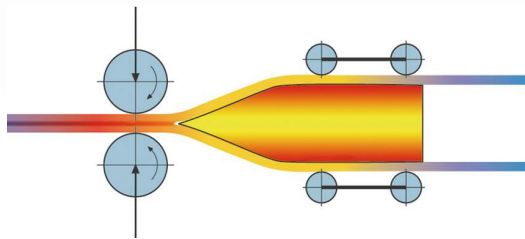

# “Combi Wedge” Welding Procedures

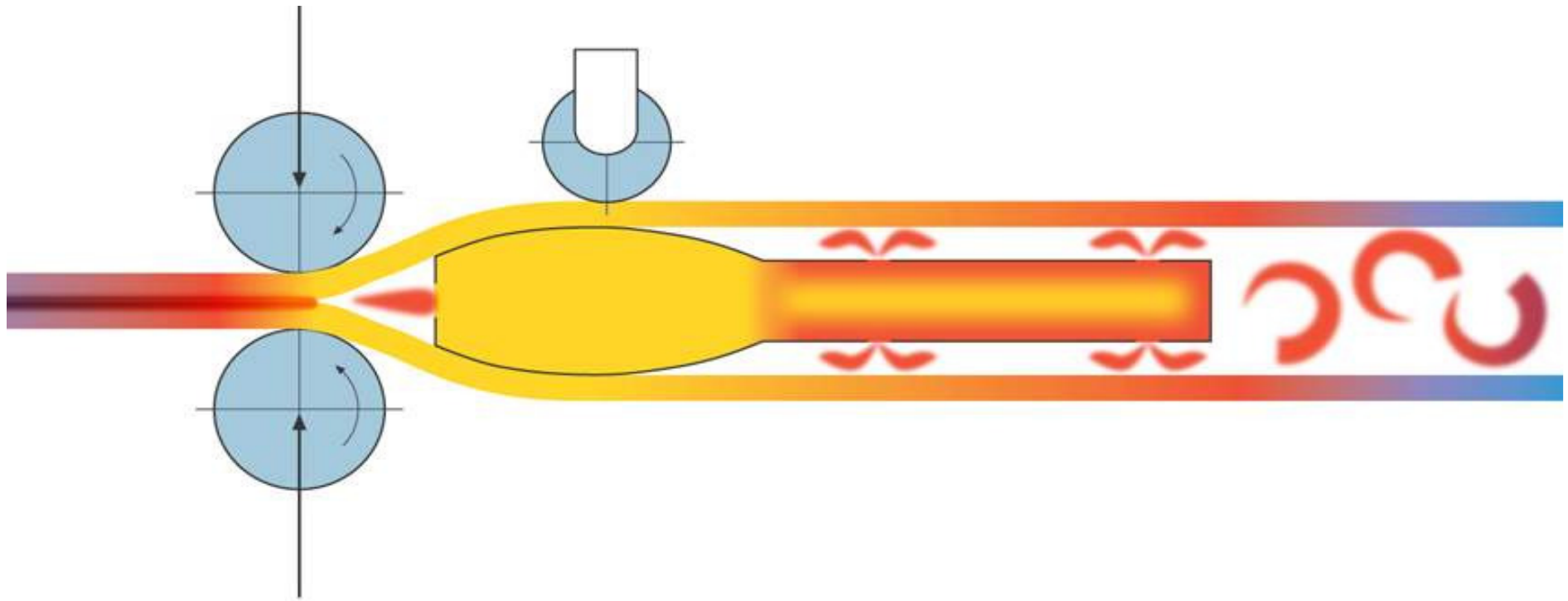

TWINNY S      TWINNY T

# “Combi Wedge” Welding Procedures

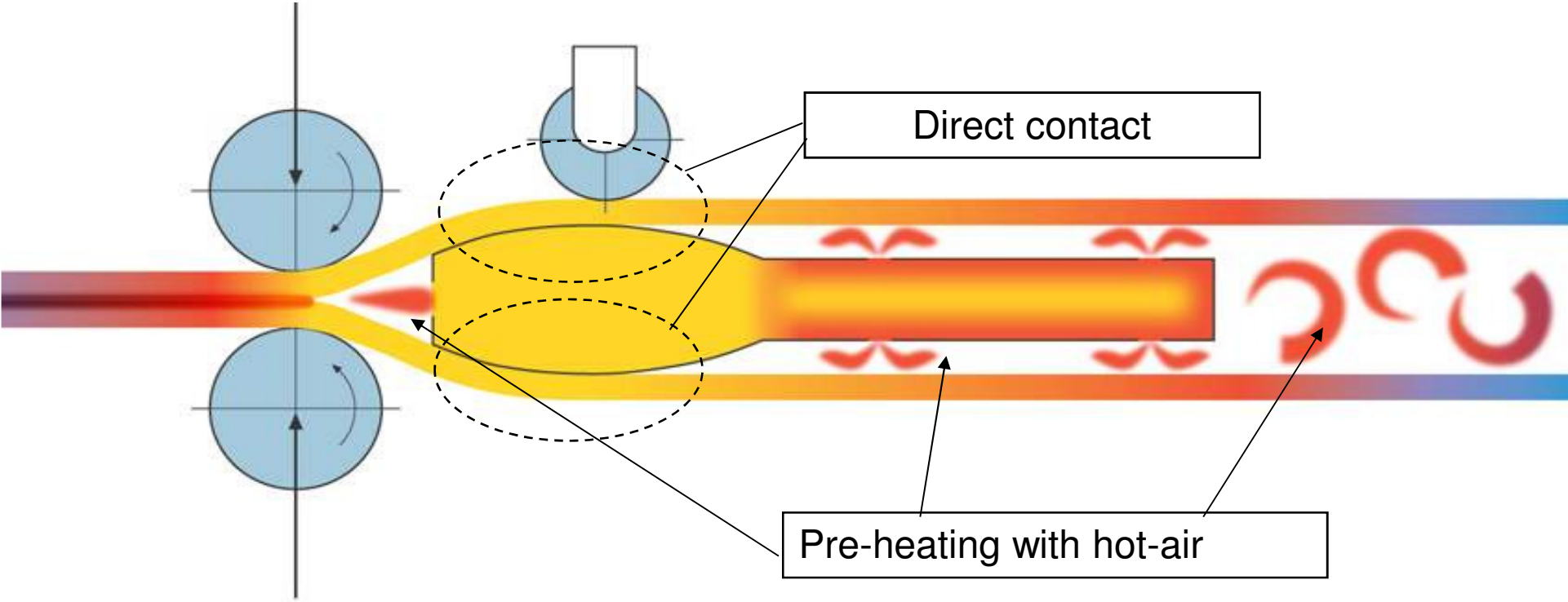

**TWINNY S      TWINNY T**

# “Combi Wedge” Welding Procedures



Combi wege long with test channel for Twinny T/S

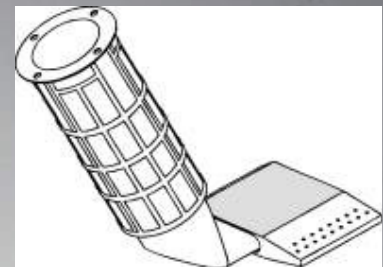
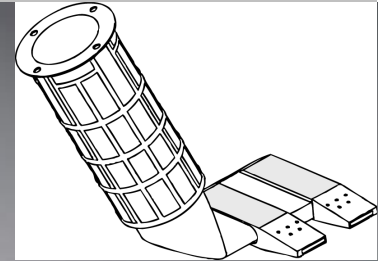



# “Wedge” Welding Procedures

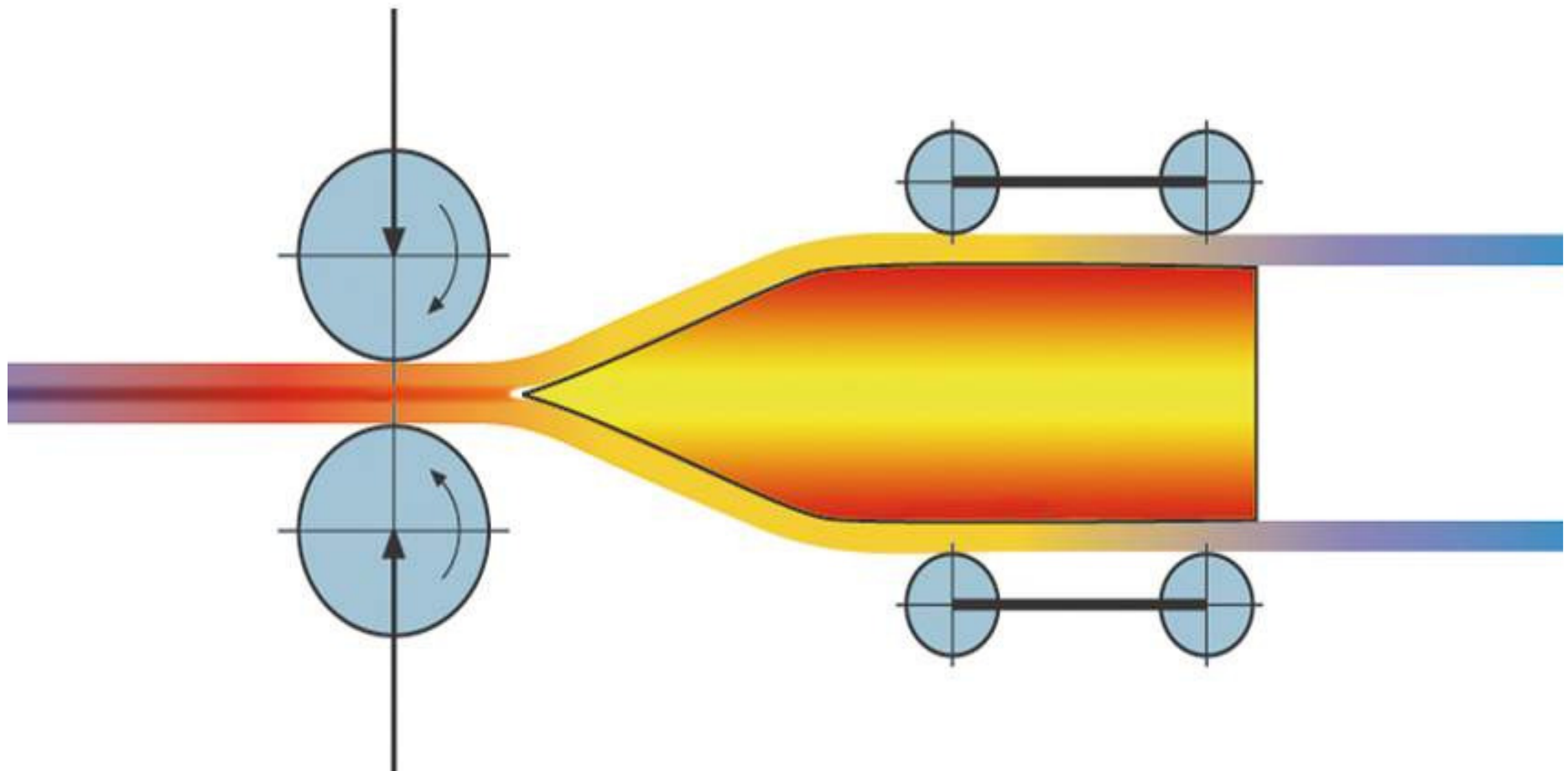

COMET ASTRO

# Copper - Steel

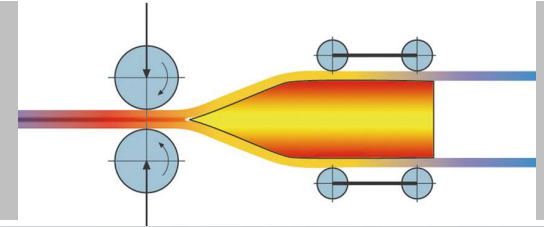

Wedge Cooper without test channel

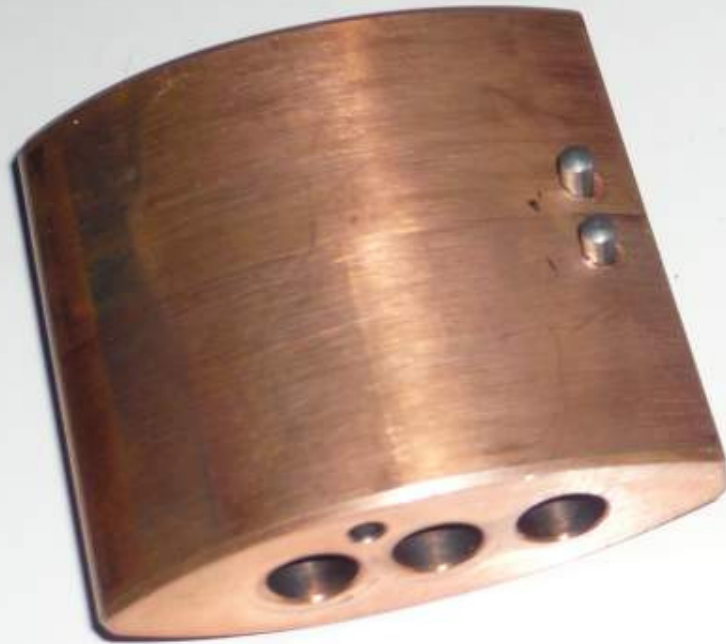

Wedge Steel with test channel



# Overview “Combi-wedge” – “Wedge”

## Combi-wedge

- + Thin material  
(down to 0,5 mm)
- + Blows away sand/dirt/humidity
- + No change of nozzle for  
PE and PVC
- Slower speed
- Energy consumption/noice
- Easy change of combi-wedge

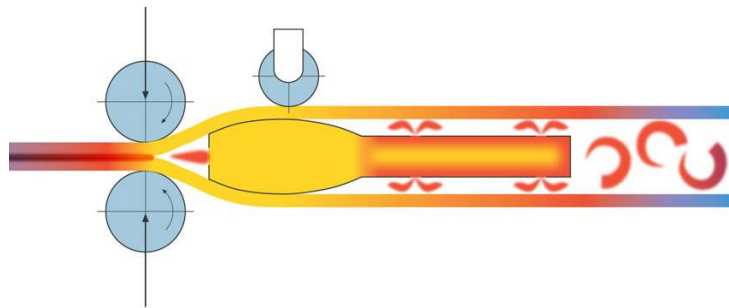

## Wedge

- + Speed
- + No noice
- + Less energy consumption
- Unsoiled plastic sheets
- Absolutely dry plastic sheets
- Wedge is difficult to change

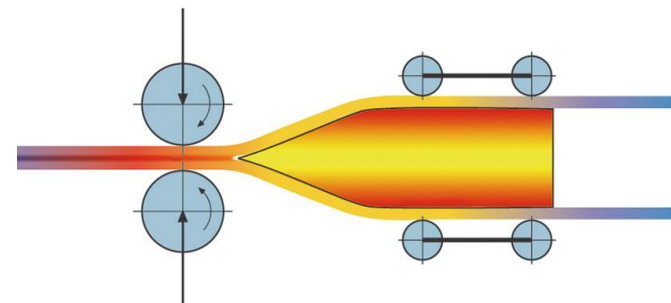



# Overview Wedge Technologies

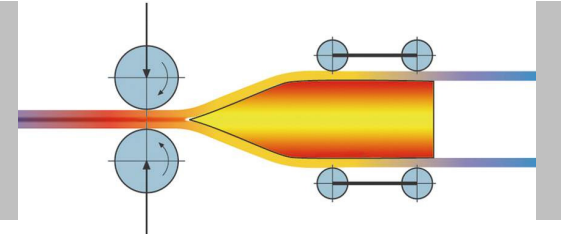

- Steel
- Copper
- Silver
- Ceramic



# Overview Wedge Technologies

## Steel, CrNi (PVC)

- + Low Costs
- Speed

## Cooper (PE/PP)

- + Speed
- Corrosion with PVC
- Cost

## Silver (PE/PP)

- +Speed
- Costs
- Corrosion (connections)

## Ceramic (PE/PP/PVC)

- + All types of material
- + Free from wear
- Costs
- Mechanical stress/water
- Heat transfer

# Copper – using PVC

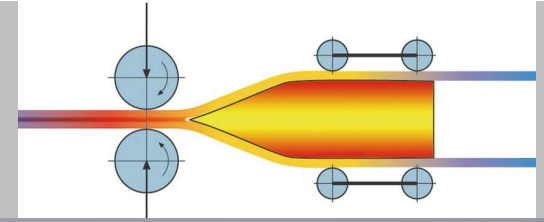

**Bad Example: wrong use of copper wedge!**  
**Corrosion caused by PVC!**





# Extrusionswelding

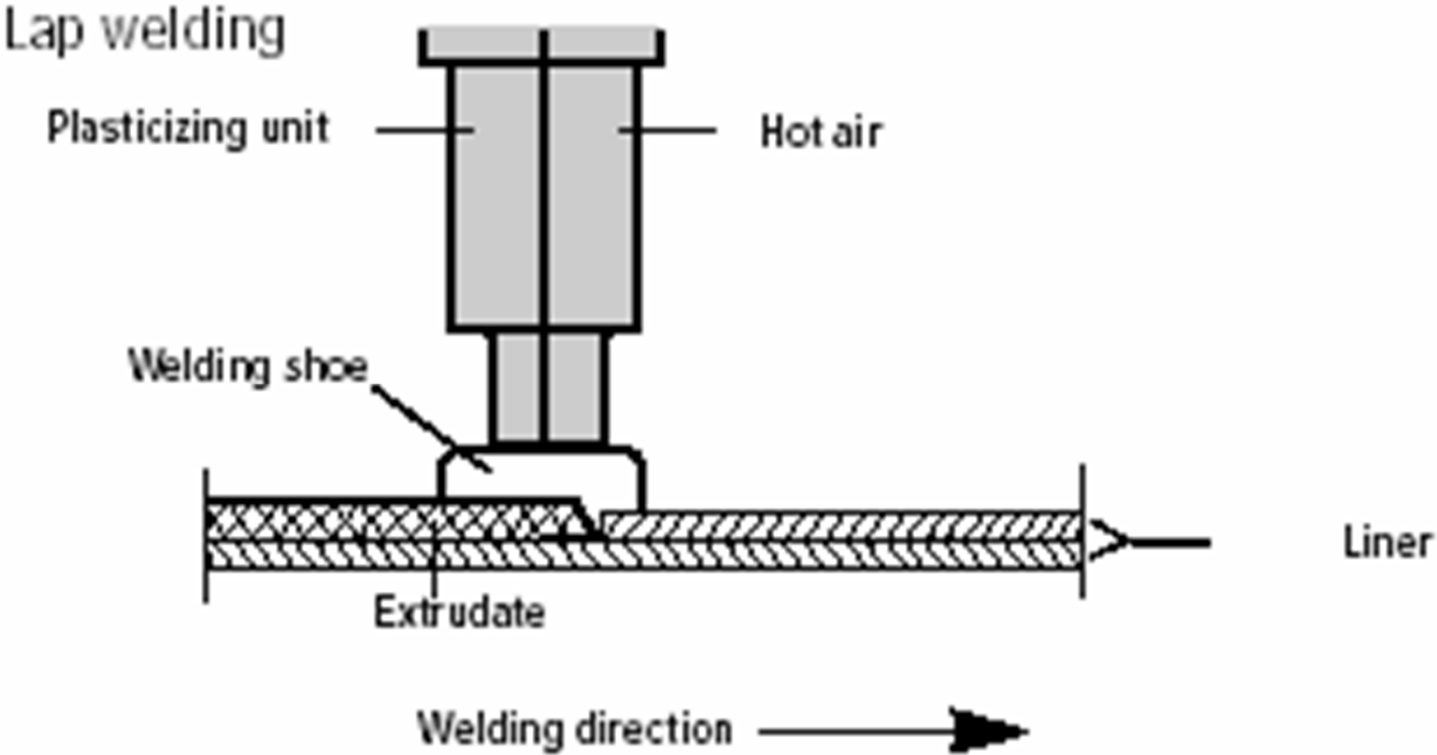

FUSION 3      WELPLAST      WELDMAX

# Extrusionswelding



# Welding Procedure Under Construction Site Conditions

## Condition of Surface

- solid underground with smooth surface without bumps
- Building sites should be free of sharp items, roots and stones.

## Environment Conditions / Weather Conditions / Rain

- In case of rain it must not be welded without any special safety measures.

## Air Temperature

- Welding procedures have to be stopped at temperatures under +5°C in order to prevent high thermal strains of the membrane.



# Welding Procedure Under Construction Site Conditions

- **Air Humidity**

High air humidity might cause perspiration water on the welding surface which is unfavourable for the seam strength (towel or pre-heat).

- **Wind**

Due to strong wind the required welding temperature might not be reached. To solve this problem, the welding temperature has to be increased up to 20–30 °C. If the wind is too strong, the welding area should be protected, or the welding process has to be stopped.

- **Sunshine**

Sunshine causes strong heat, especially of black membranes. This causes an increased thermal expansion of the membrane and results in wrinkles. The welding process becomes more difficult, and when cooling down abnormal strain in the seam area occurs.

# Welding shape according DVS 2225 Teil 1

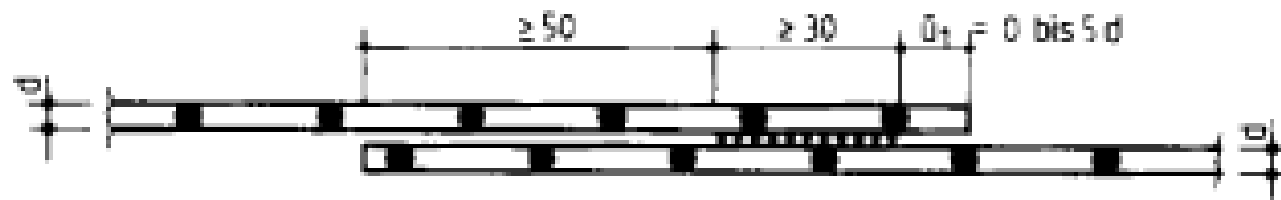

Lap joint without testing channel – single weld  
(Welding with or without welding filler)

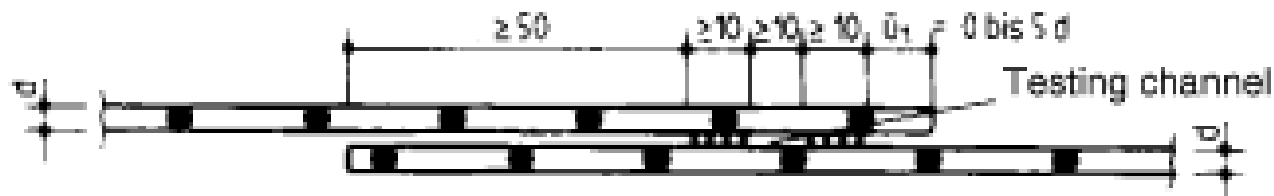

Lap joint with testing channel – double weld  
(Welding with or without welding filler)

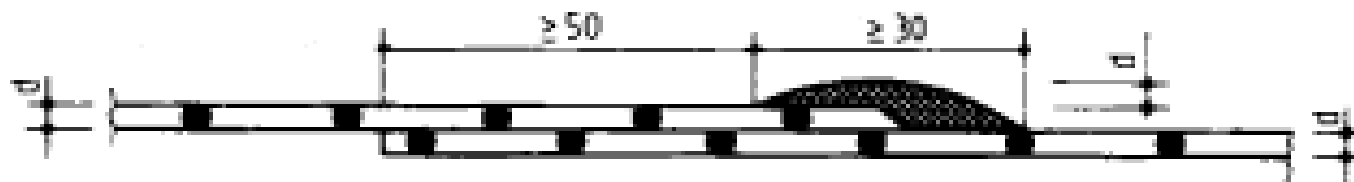

Coating weld (extrusion welding)

# Test procedure: Test according DVS 2225 Teil 2

- **Outer appearance of the seam**  
(visual control of notches, grooves and irregularities)
- **Examination of the dimension** (measuring)
- **Strength test** (tensile test)
- **Leak-tightness test** (Testing with compressed air)

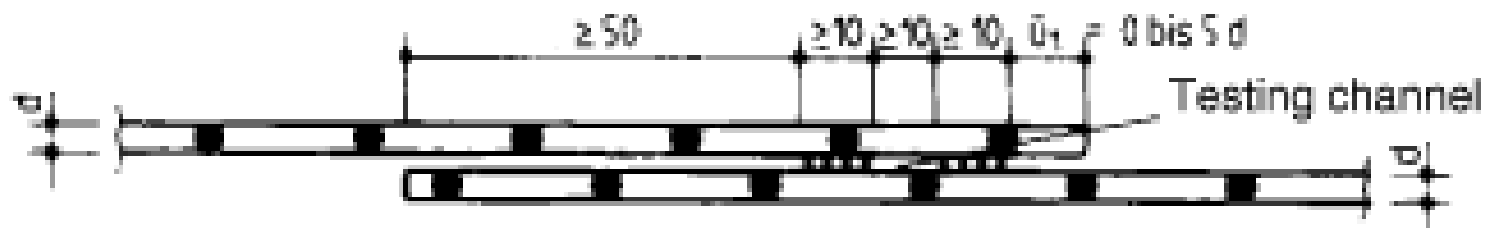

Lap joint with testing channel – double weld  
(Welding with or without welding filler)

**LEISTER**

## Automatic Machines

- COMET
- ASTRO
- TWINNY T
- TWINNY S





# Automatic Machines



# COMET (Hot wedge welding)

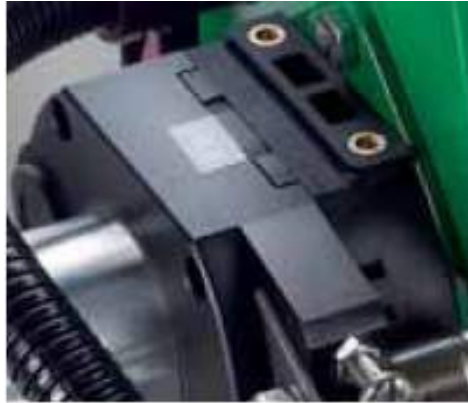

Drive technology designed for the highest demands



Digital temperature and speed display



Adjustment of welding force for different materials



Double drive and pressure system for constant pressure

# COMET (Hot wedge welding)

Power consumption	1500 W		1200 W		700 W	
Type of material	Wedge length	Material thickness	Wedge length	Material thickness	Wedge length	Material thickness
PE-HD, PE-C, PP	70 mm copper	1.5 – 2.0 mm	50 mm copper	0.5 – 1.5 mm	20 mm steel	0.5 – 1.0 mm
PE-LD	70 mm copper	2.0 – 3.0 mm	50 mm copper	1.0 – 2.0 mm	20 mm steel	0.5 – 1.0 mm
PVC-P	70 mm steel	2.0 – 3.0 mm	50 mm steel	1.0 – 2.0 mm		

# COMET USB



- Recording of welding parameters
- Very easy handling
- Proved under heavy duty conditions



# COMET USB



- Pressure measurement with very precise sensor
- Display read out of pressure

# USB-Report COMET USB

```

LEISTER
File-number: 0708-001
LEISTER Switzerland
TWINNY T
Software Release 3.0A USB
Date:      08.07.2009
Time:      10:37:07
v=         1.8m/min
t=         480°C
Intervall= 5cm
initial value= 390N

Distance   Speed   Temperature   Force
[cm]       v[m/min]  T[°C]         F[N]
0          0        1.6           480       605
0          0        1.6           480       605
5          1.8     1.8           480       605
10         1.8     1.8           480       710
15         1.8     1.8           480       735
20         1.8     1.8           480       735
25         1.8     1.8           481       755
30         1.8     1.8           481       760
35         1.8     1.8           480       755
40         1.8     1.8           480       775
45         1.8     1.8           480       775
50         1.8     1.8           480       775
55         1.8     1.8           480       770
60         1.8     1.8           480       775
65         1.8     1.8           480       775
70         1.8     1.8           480       780
75         1.8     1.8           480       780
80         1.8     1.8           479       780
85         1.9     1.8           480       640
90         1.9     1.8           480       640

End of File
    
```

- Client text can be edited
- File-name (date and number)
- Type of tool and software-version
- Date and time
- Welding parameters
- Pressure value for start of recording
- Recording of welding parameters every 5cm
- End of recording



# Wedge Welding Machine

## ASTRO Wedge welding machine



- Worldwide the fastest wedge welding machine
- Very robust
- One-handle operation
- HD-PE 1.5 - 3 mm



# ASTRO USB



- Data recording all important welding parameters
- Akustical alarm funktion
- For work according DVS 2225-4



# ASTRO CPL

- For concrete protection liner
- Faster than conventional welding procedures
- Up to 3.5mm membranes /up to 19mm nap-material



# Concrete Guard Plates – Nap Membranes



Omega - naps

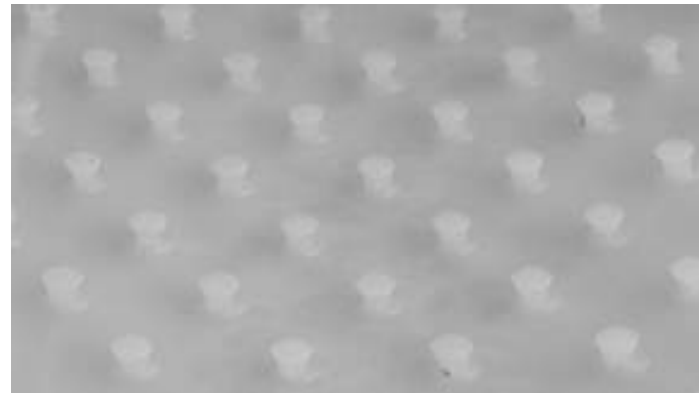

T - naps



V - naps



Flat naps

# TWINNY T Combi wedge



- Small and handy
- Combi wedges easy to change
- Suitable for all materials
- For Membranes of 0.3 - 2.0mm
- Digital controlled
- USB-Data-Recording possible

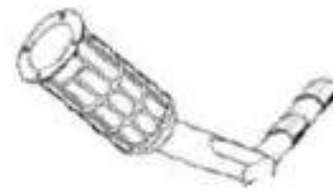

<b>100.517</b>	Short combiwedge, 50 mm with test channel
<b>100.518</b>	Short combiwedge, 50 mm without test channel
<b>&gt; TWINNY T &gt; TWINNY S</b>	

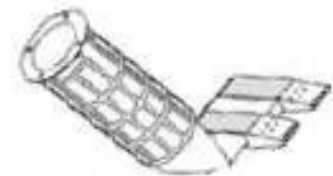

<b>100.525</b>	Long combiwedge, 50 mm with test channel
<b>100.526</b>	Long combiwedge, 50 mm, without test channel
<b>&gt; TWINNY T &gt; TWINNY S</b>	

# TWINNY T USB – Data recording



- Recording of welding parameters
- Very easy handling
- Proved under heavy duty conditions



# TWINNY T USB – Data recording



- Pressure measurement with very precise sensor
- Display read out of pressure

# USB-Report TWINNY T

```

LEISTER
File-number: 0708-001
LEISTER Switzerland
TWINNY T
Software Release 3.0A USB
Date:      08.07.2009
Time:      10:37:07
v=         1.8m/min
t=         480°C
Intervall= 5cm
initial value= 390N

Distance   Speed   Temperature   Force
[cm]       v[m/min]  T[°C]         F[N]
0          0        1.6           480       605
0          0        1.6           480       605
5          1.8      1.8           480       605
10         1.8      1.8           480       710
15         1.8      1.8           480       735
20         1.8      1.8           480       735
25         1.8      1.8           481       755
30         1.8      1.8           481       760
35         1.8      1.8           480       755
40         1.8      1.8           480       775
45         1.8      1.8           480       775
50         1.8      1.8           480       775
55         1.8      1.8           480       770
60         1.8      1.8           480       775
65         1.8      1.8           480       775
70         1.8      1.8           480       780
75         1.8      1.8           480       780
80         1.8      1.8           479       780
85         1.9      1.9           480       640
90         1.9      1.9           480       640

End of File
    
```

- Client text can be edited
- File-name (date and number)
- Type of tool and software-version
- Date and time
- Welding parameters
- Pressure value for start of recording
- Recording of welding parameters every 5cm
- End of recording



# TWINNY S Combi wedge



- Ideal for tunnel construction
- Low weight
- For membranes of 0.3mm – 2.0mm
- Suitable for all materials
- Easy to use
- Highest speed up to 6 m/min



**100.517**

Short combiwedge, 50 mm with test channel

**100.518**

Short combiwedge, 50 mm without test channel

> **TWINNY T** > **TWINNY S**

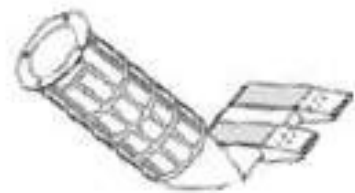

**100.525**

Long combiwedge, 50 mm with test channel

**100.526**

Long combiwedge, 50 mm, without test channel

> **TWINNY T** > **TWINNY S**

# TWINNY S Combi wedge



## Technical Data

Voltage	V~	230		
Power consumption	W	2900		
Frequency	Hz	50 / 60		
Temperature	°C	20 – 600		
Speed	m/min	0.2 – 2.5	0.8 – 4	1.2 – 6
Welding pressure	N	max. 1000	max. 500	max. 500
Air flow (20°C)	l/min	Level 2: 150 Level 3: 190		
Noise emission level L <sub>pA</sub>	dB	71		
Size (L × W × H)	mm	350 × 390 × 270		
Weight	kg	6.5 – 6.9 (with 3 m cord)		
Marking of conformity		CE		
Approval mark		Ⓢ		
Certification scheme		CCA		
Protection class II		□		
Article no with Euro plug		119.027	119.008	128.808
Accessories page 14		Further models on request		



# TWINNY S: Different Gears



## Gear 144:1

- Speed of *1.4 – 4.0 m/min*
- Version up to 6m/min (128.808)
- Max. pressure of 500N
- Thin materials are suitable
- Current limiter (motor switches off)

## Gear 256:1

- Speed of *0.8 – 2.5 m/min*
- Max. pressure of 1000N
- Thick materials are suitable
- Current limiter (motor switches off)
- Version rapida up to 6 m/min

# TWINNY S / T: Application Range Nozzles

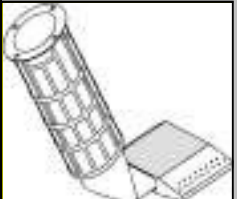
Combi Wedge		Material	Thickness
	1	PE-HD, PE-C, PFA, PP	0.3 - 1.0mm
		PVC-P, PE-LD, EVA	0.3 - 2.0mm
	2	1 short combi wedge with test channel	
		2 short combi wedge without test channel	
Combi Wedge		Material	Thickness
	3	PE-HD, PE-C, PFA, PP	0.8 - 2.0mm
		PVC-P, PE-LD, EVA	1.0 - 3.0mm
	4	3 long combi wedge with test channel	
		4 long combi wedge without test channel	

# Differences of Hot Wedge and Combi Wedge

## Hot Wedge



## Combi Wedge



### Advantages:

- Small heat output
- Compact design
- Low noise

- No change of nozzle (PVC/PE)
- Suitable for thin materials
- Blows away dirt in the seam
- Stress-free welding procedure

### Disadvantages:

- Change of wedge PVC/PE
- Depending on weather
- Cleaning of seam absolutely
- Necessary when wet

- High heat output (wattage)
- Slow speed

# Useful welding parameter for HDPE Membranes

Please note: the indicated welding parameter may vary depending on the ambient temperature and the material configuration. Test welds needs to be done and the parameter aligned accordingly !

Wedge			HD-PE							LD-PE					PVC						
			0.3	0.5	1.0	1.5	2.0	2.5	3.0	0.3	0.5	1.0	1.5	2.0	0.8	1.0	1.5	2.0	2.5	3.0	
COMET	copper	95 mm			380° C 3.2 m <sub>min</sub> 600 N	420° C 3.0 m <sub>min</sub> 800 N	420° C 2.8 m <sub>min</sub> 1000 N	420° C 2.5 m <sub>min</sub> 1000 N					400° C 3.2 m <sub>min</sub> 600 N	400° C 3.0 m <sub>min</sub> 800 N							
		70 mm			380° C 2.5 m <sub>min</sub> 600 N	420° C 2.5 m <sub>min</sub> 800 N	420° C 2.2 m <sub>min</sub> 1000 N	420° C 2.0 m <sub>min</sub> 1000 N					400° C 2.8 m <sub>min</sub> 600 N	400° C 2.5 m <sub>min</sub> 800 N							
	steel	70 mm																400° C 2.8 m <sub>min</sub> 700 N	420° C 2.5 m <sub>min</sub> 800 N	420° C 2.4 m <sub>min</sub> 1000 N	
		50 mm																400° C 2.8 m <sub>min</sub> 600 N	420° C 2.5 m <sub>min</sub> 600 N		
	steel	20 mm	400° C 2.0 m <sub>min</sub> 400 N	420° C 1.5 m <sub>min</sub> 500 N														350° C 2.0 m <sub>min</sub> 400 N			
ASTRO					420° C 5.0 m <sub>min</sub> 1250 N	420° C 4.5 m <sub>min</sub> 1500 N	420° C 4.2 m <sub>min</sub> 1500 N	420° C 4.0 m <sub>min</sub> 1500 N													
Combi Wedge																					
TWINNY S		short	450° C 3.5 m <sub>min</sub> 400 N	500° C 3.0 m <sub>min</sub> 600 N	500° C 2.0 m <sub>min</sub> 800 N									500° C 2.5 m <sub>min</sub> 400 N	550° C 2.5 m <sub>min</sub> 500 N	600° C 2.5 m <sub>min</sub> 600 N					
		long				550° C 2.0 m <sub>min</sub> 800 N	550° C 1.8 m <sub>min</sub> 1000 N						500° C 2.5 m <sub>min</sub> 600 N	550° C 2.0 m <sub>min</sub> 700 N				550° C 2.5 m <sub>min</sub> 600 N	580° C 2.5 m <sub>min</sub> 700 N	600° C 2.0 m <sub>min</sub> 800 N	
TWINNY T		short	420° C 3.2 m <sub>min</sub> 400 N	500° C 3.0 m <sub>min</sub> 600 N	500° C 2.0 m <sub>min</sub> 800 N									500° C 2.5 m <sub>min</sub> 400 N	550° C 2.5 m <sub>min</sub> 500 N	560° C 2.3 m <sub>min</sub> 600 N					
		long				550° C 2.0 m <sub>min</sub> 800 N	550° C 1.8 m <sub>min</sub> 1000 N						500° C 2.5 m <sub>min</sub> 600 N	550° C 2.0 m <sub>min</sub> 700 N				550° C 2.5 m <sub>min</sub> 600 N	550° C 2.5 m <sub>min</sub> 800 N	560° C 2.0 m <sub>min</sub> 1000 N	



# UNIROOF (Tacking)

- For tacking of membranes as a preparation for long extrusionsweldings
- For welding of covers
- Fast and safe
- Professional



**LEISTER**

## Handextruder

- FUSION 3
- WELDPLAST S6
- WELDPLAST S4
- WELDPLAST S2





# Extrusions welding



Connections and drainages



Repair badge



Coating weld (extrusion welding)



# Extrusions welding



- Test welding landfill

# LEISTER-Extruder

Weldplast S2



Weldplast S2  
TPO/FPO



Fusion 3



Weldplast S4



Weldplast S6



# Extrusion Welding FUSION 3



- Compact and handy
- Very simple handling
- Unique price/performance ratio
- Protection of drive with overload and temperature protection
- Welding shoe 360 degrees swiveling
- **output**
  - PE (3mm) 1.6 – 2.3 kg/h
  - PE (4mm) 2.0 – 3.5 kg/h
  - PP (3mm) 1.3 – 2.0 kg/h
  - PP (4mm) 1.5 – 2.7 kg/h
- **weight 7.2kg**
- **dimension 670 x 90 x 180 mm**
- **Delivery in a strong case**

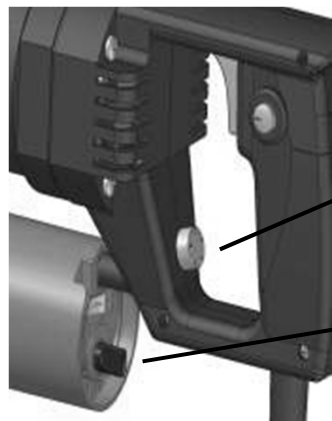

Potentiometer  
output

Potentiometer  
airtemperature

# WELDPLAST S6

- Very high output with 6kg/h
- Extremely strong preheat
- Ergonomic “steering wheel” handle
- Also for Tool rest
- Digital control of welding parameter
- Compact housing
- Protects electronics, motor & mechanics in rough conditions
- Security through restart protection
- User friendly
- Maintenance free blower unit
- CE Conformity, Tested externally by SEV (official certification body by IEC)
- Extrem strong carrying box



# WELDPLAST S4



- Digital close loop control and read out of plast and air
- Multifunctional display
- Maintenance-free blower
- DVS und CE-Conform
- Twist free welding rod feed on both sides
- Output 4kg/h
- Gewicht 8.7 kg
- Dimension 560 x 110 x 300 mm
- Delivery in strong LEISTER-Case



# WELDPLAST S2



- Closed-loop control for plast and pre-heating
- Multifunctional display
- Twist free welding rod feed on both sides
- 360° turnable welding shoe
- Stepless adjustable handle
- Electronic drive protection
- Maintenance-free blower
- Small and powerfull
- One push settings for common materials
- Free configurable menus

**LEISTER**

## Semi automatic and hand tools



# Hand Tools – Semi Automatic Welding Tools

**TRIAC PID**



**TRIAC DRIVE**



**TRIAC S**



# TRIAC DRIVE – Application



- Horizontal, vertical, diagonal
- Different welding seam widths
- Applicable in the most confined spaces
- Ideal job for diagonal connections in a tunnel

# Civil Engineering

## Triac Drive for sealing strips





# TRIAC S / PID – Application



Overlap welding of connections with TRIAC PID (PVC-P or modified PE)



Tacking of HDPE membrane prior to extrusion welding

**LEISTER**

## Test equipment

- EXAMO
- EXAMO USB
- AIRPRESSURE TEST
- VAKUMTESTING



# EXAMO for peeling, tensile and shearing tool



- Portable and designed for construction site conditions
- USB-Data-Recording
- Optional for geotextiles
- Calibration-KIT available

# Test Procedure: Test according DVS 2225 Part 2

## Strength test (tensile test)



Bild 4. Probenahme und Beanspruchung beim Schälversuch.



# EXAMO USB

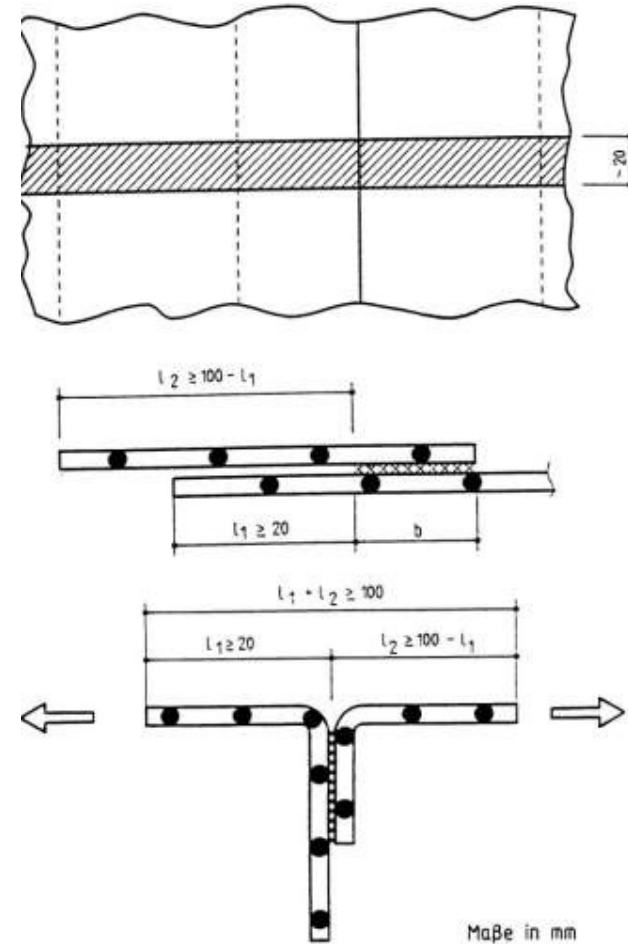

- Recording of measurements values direct to USB-Memory stick
- Very easy to use
- Proved also under heavy duty conditions



# EXAMO USB report

File-number: 0515-003

LEISTER Switzerland  
EXAMO  
Software Release 2.0

Date: 15.05.2009  
Time: 10:32:18  
Speed= 2.0inch/min  
Init.Length= 3.9inch  
Init.Tension= 2lb

Strain [%]	F_PV [lb]	Speed_PV [inch/min]	
0	12	0	
0	6	1.96	
1	10	1.96	
2	12	1.96	
3	16	1.96	
4	17	1.96	
5	20	1.96	
6	21	1.96	
7	24	1.96	
8	24	1.96	
9	26	1.96	
10	26	1.96	

487	65	1.96	
488	66	1.96	
489	65	1.96	
490	66	1.96	
491	66	1.96	
492	66	1.96	
493	65	1.96	
FPeak:			
494	66	1.96	
FTear:			
494	61	1.96	
End of File			

Name	Geändert am	Größe
0515-002	15.05.2009 10:03	7 KB
0515-003	15.05.2009 10:32	7 KB

## Reporting of:

- Date, time
- Type, software-version
- File-number
- Start-parameters
- Tensile, elongation, speed
- Max. tensile, max. elongation

# EXAMO USB visualisation

- It's very easy to make diagrams !

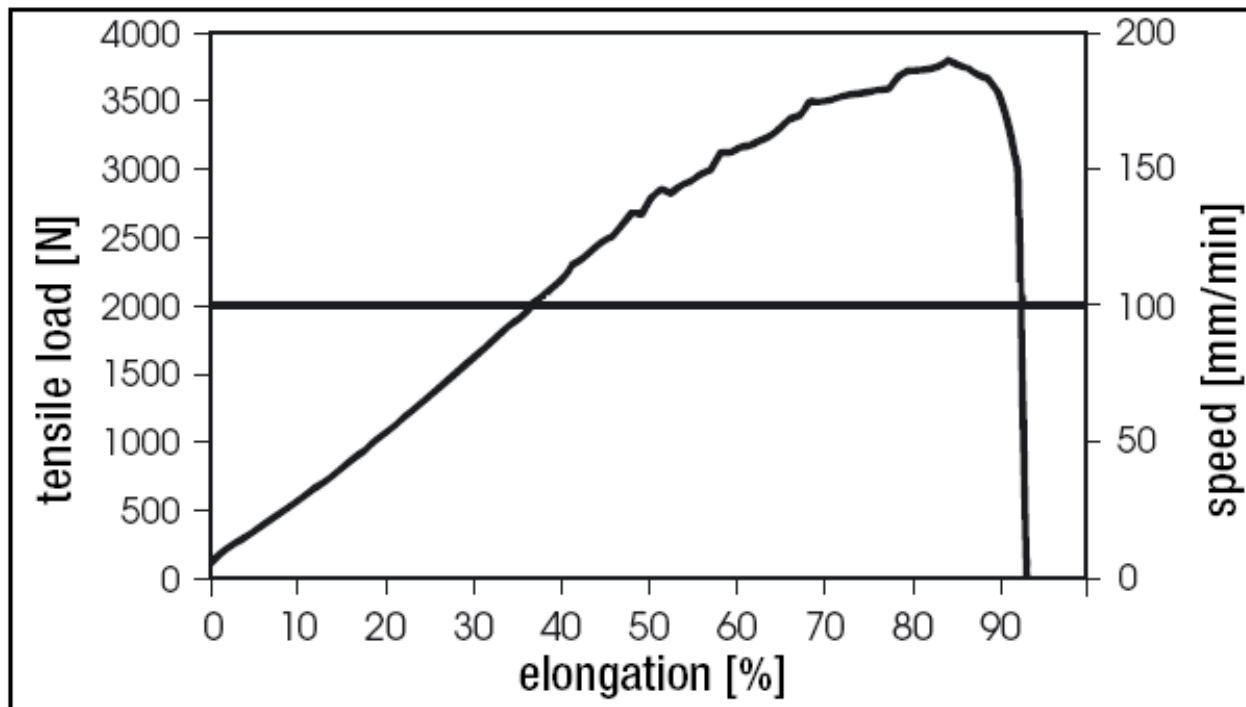

# Test Procedure: Test according DVS 2225 Teil 2

Leak-tightness test (Testing with compressed air)

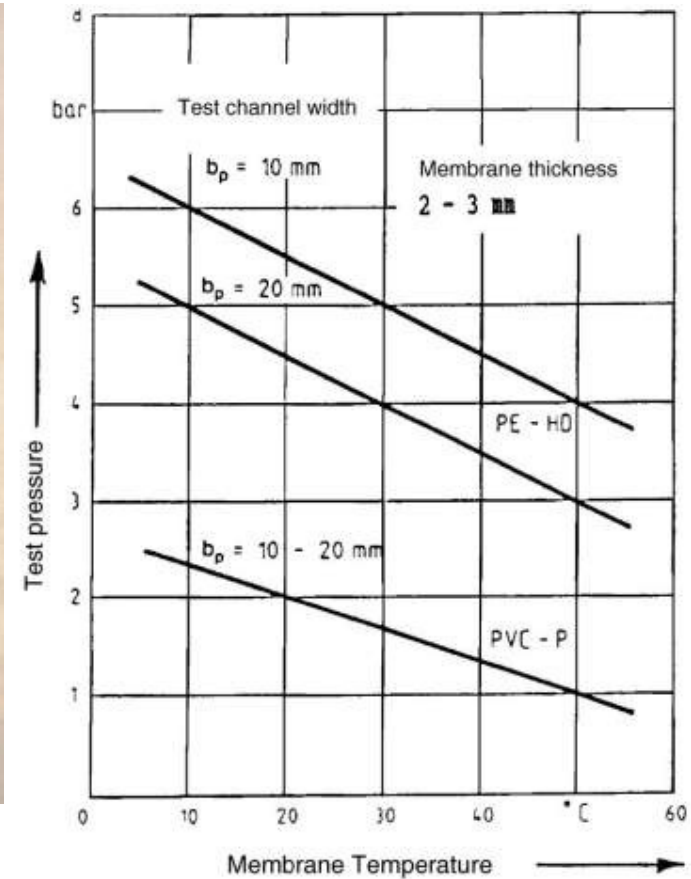

Figure 5. Test pressure as a function of the membrane temperature during the compressed air test.

# Test Procedure: Test according DVS 2225 Teil 2



- Easy and precise seam testing
- High security due to hand and needle protection
- Practical storage case

## Article no.:

142.475      Air pressure test manometer with testing needle

142.569      Spare needle

Included in delivery are storage case and o-rings



More security for user and device:  
hand and needle protection



Easy and precise non-destructive seam testing on the construction site

# Vacuum bell



- 109.795 Vacuum bell Ø320mm
- For vacuum testing of T-connections and extrusionsweldings



109.795

Vacuum bell Ø 320 mm



**LEISTER**

# **Promotion Civil Engineering – Tunnel Construction**

- Leaflet
- Flyer
- DVD's
- Success stories
- Poster



# LEISTER Promotion

- Posters
- Leaflet civil engineering
- Flyer WELDPLAST S6
- Flyer WELDPLAST S2

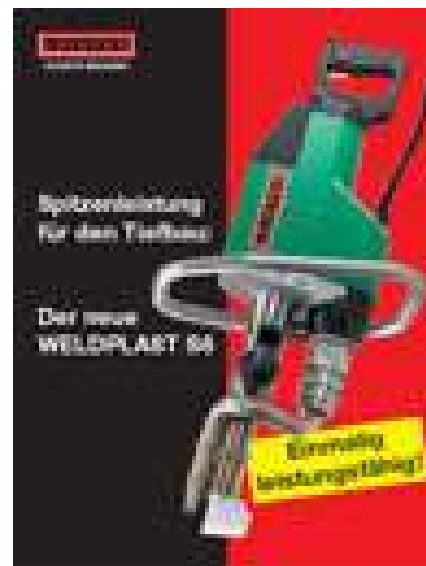

# LEISTER Promotion

- Success stories
- [www.LEISTER.com](http://www.LEISTER.com) → down loads



# LEISTER Promotion

- DVD COMET



# LEISTER Promotion

## Internet

- Internet [www.leister.com](http://www.leister.com)
- Data sheets
- Instruction manuals
- youtube videos

## Additional

- Leister Promotion in magazines
- Powerpoints

## Extranet

- Product- and application pictures
- Leister Logos





**Many thanks for  
your attention!**

**FURRER Thomas  
Product Manager Plastic Welding**

© Copyright by Leister 2011

