

LEISTER®

English

WELDPLAST 600/605



WELDPLAST 600



WELDPLAST 605

Leister Technologies AG
Galileo-Strasse 10
6056 Kaegiswil/Switzerland
Tel. +41 41 662 74 74
Fax +41 41 662 74 16
www.leister.com
sales@leister.com

Table of contents

1	Important safety instructions	4
1.1	Intended use	5
1.2	Non-intended use	5
2	Technical data	6
3	Transport	7
4	Your WELDPLAST 600/605	8
4.1	Type plate and identification	8
4.2	Scope of delivery (standard equipment in the case)	8
4.3	Overview of device parts	9
5	Settings on the WELDPLAST 600/605	11
5.1	Adjusting the handle	11
6	Commissioning and operation/operation	12
6.1	Work environment and safety	12
6.2	Prepare device	13
6.3	Starting the device	13
6.4	Welding sequence	14
6.5	Finishing welding	15
6.6	Switching off the device/Maintenance	15
7	Quick Reference Guide WELDPLAST 600/605	16
7.1	Switching on/Starting	16
7.2	Switching off	16
8	The control panel of the WELDPLAST 600/605	17
8.1	Function buttons	17
8.2	Display	18
8.3	Setting the welding parameters	18
8.4	Display symbols of the status display (Display 40)	19
8.5	Display symbols of the work display (Display 35)	20
9	Settings and functions of the WELDPLAST 600/605 software	21
9.1	Overview menu navigation basic settings	21
9.2	Overview menu navigation Advanced Mode	23
9.3	Recipes	25
9.4	Displaying nominal values (Set values)	26
9.5	Eco mode	27
9.6	LQS Data Recording settings	28
9.7	WLAN settings	31
9.8	Machine settings	31
9.9	Info mode	35
9.10	Duty info	35
9.11	General Info	35
9.12	Warnings and error messages	36

10 Accessories	38
11 Maintenance	38
11.1 Lubrication axial groove ball bearing	38
11.2 Cleaning of the filters	38
12 Service and repair	39
13 Training	39
14 Declaration of Conformity	39
15 Disposal	39

Operating Manual (Translation of the Original User Manual)

Congratulations on your purchase of the WELDPLAST 600/605.

You have chosen a first-class hot air welder extruder.

It was developed and produced in accordance with the latest state-of-the-art technology in the plastics-processing industry. It has also been manufactured using high-quality materials.



We recommend that you always keep the instruction manual with the device.

WELDPLAST 600/605 hot air welder extruder



You can find more information on the WELDPLAST 600/605 at www.leister.com

1. Important safety instructions

In addition to the safety instructions contained in the individual sections of this instruction manual, the following regulations must always be observed.



Read through the operating instructions before using for the first time. Always store these operating instructions with the device.

Do not pass the device on to anyone else without the operating instructions.

Warning



Hazardous voltage, danger to life

There is a danger to life from electric shock due to electrical voltage. The extruder must therefore only be connected to sockets and extension cables with a protective earth conductor. Protect the extruder from moisture and wet conditions. Before starting the device, check the power cord, the plug and the extension cable for electrical and mechanical damage. The extruder may only be opened by instructed, qualified personnel.



Risk of burning

Do not touch exposed metal parts or escaping material while they are hot. The device should always first be allowed to cool down. Never point the hot air flow at people or animals.



The local supply **voltage** must match the nominal **voltage** specified on the device. In case of doubt, the responsible power company must be consulted.

The main switch must be switched off in the event of a mains voltage failure.



Risk of glare

Direct eye contact with the LED light beam must be avoided.



The device should only be operated by **trained specialists** or under their supervision. Children are not permitted to operate the device.

1.1 Intended use

The WELDPLAST 600/605 is designed for professional welding of thermoplastic materials made from PE and PP in the fields of

- Vessel construction
- Pipeline construction
- Equipment construction
- Landfill construction
- Repairs

Use only original Leister spare parts and accessories; otherwise, any warranty or guarantee claims will be invalidated.

Welding procedures and types of materials

- Use the WELDPLAST 600/605 for welding thermoplastic materials based on polyethylene and polypropylene only. (PE-LD, PE-LLD, PE-HD, PP)











Toxic gases or vapors may be hazardous when welding with incorrect materials or when welding at too high a temperature.

1.2 Non-intended use

Any use other than the use specified in 1.1 or beyond the intended use is deemed to be improper use.

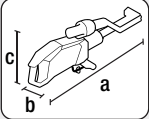
2. Technical data

			WELDPLAST 600 230 V	WELDPLAST 605 230 V
	Voltage	V~	230	230
	Power	W	3680	3680
	Frequency	Hz	50/60	
	Temperature	°C plastic °F Air	Max. 260 Max. 300	
	Air volume	%	45 – 100	
	Drive	%	60 – 100	
	Noise level	L _{pA} (dB)	<70 (K = 3 dB)	
	Vibration level	a _h (m/s ²)	< 2.5 (K = 1.5 m/s ²)	
	Weight (without power cord)	kg lbs	12.2 26.9	12.6 27.8
 <p>Weight (not inc. welding shoe)</p>	a)	mm inch	809 31.9	
	b)	mm inch	140 5.5	
	c)	mm inch	273 10.7	
			 	

Subject to change without prior notice.

3. Transport



Comply with applicable national regulations regarding the carrying or lifting of loads.
The weight of your WELDPLAST 600/605 including the transport box is 18 kg (14 kg without transport box).

Use the hot air welder extruder's transport box included with delivery only (see  scope of delivery [4.2]).



The **hot air blower (15)** and **jacket heating (10)** must be allowed to cool down sufficiently before transport



Do not store flammable materials (e.g. plastic, wood, or paper) in the transport box.



Never use the **carrying handle (5)** on the device or on the transport box for transporting with a crane.

4. Your WELDPLAST 600/605

4.1 Type plate and identification

The model and serial number are indicated on your device's **type plate (20)**. Transfer this information to your operating instructions; in the event of any inquiries to our representatives or authorized Leister service center, please always refer to this information.

Model:.....

Serial no.:.....

Example:

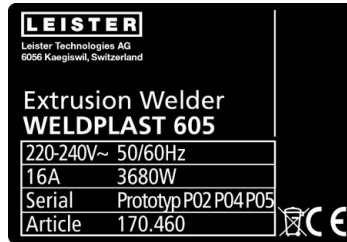
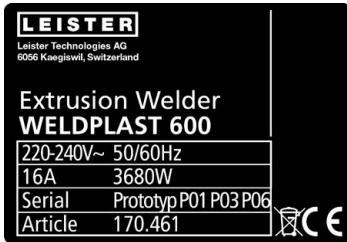

4.2 Scope of delivery (standard equipment in the case)

- 1 x WELDPLAST 600/605
- 1 x Welding shoe
- 1 x Additional handle (WELDPLAST 600 only)
- 1 x stand (WELDPLAST 600 only)
- 1 x specialized handle (WELDPLAST 605 only)

4.3 Overview of device parts

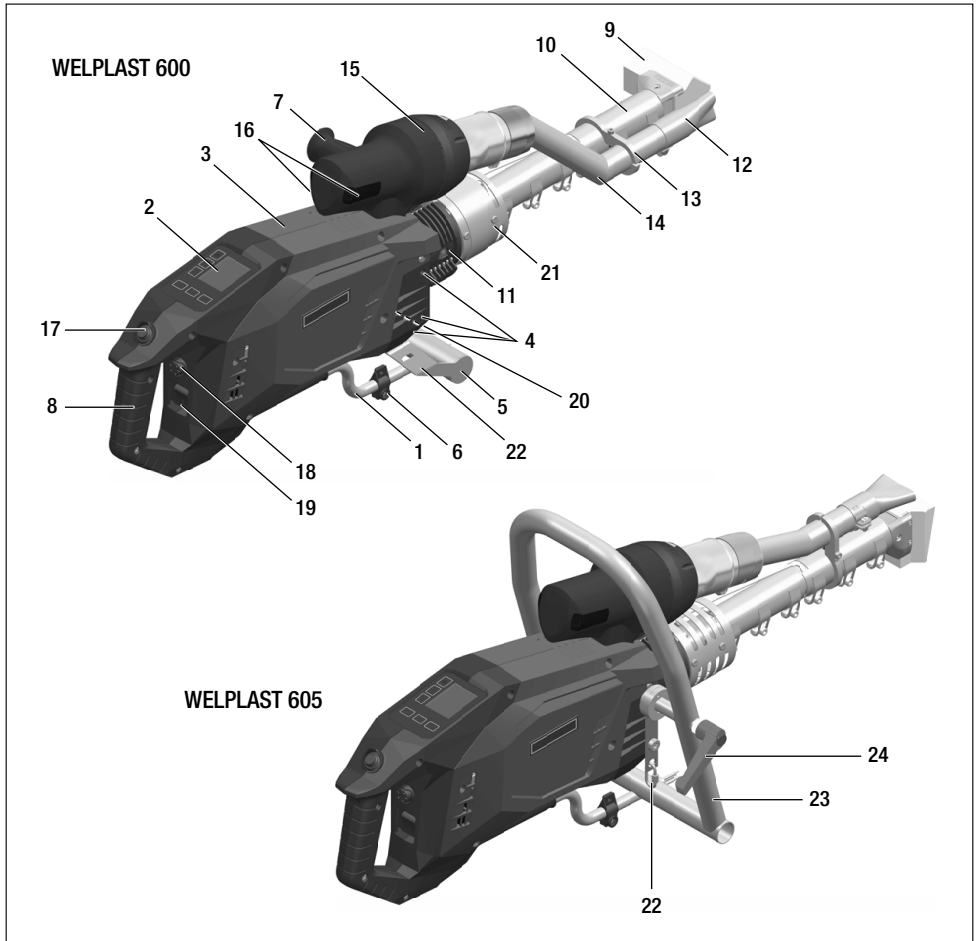

- | | |
|-------------------------------------|-------------------------------------------|
| 1. Mains connection cable | 13. Pipe clamp |
| 2. Control panel | 14. Hot air duct |
| 3. Housing | 15. Hot air blower |
| 4. Fixing thread (8 x M8) | 16. Filter |
| 5. Stand | 17. Drive on/off switch |
| 6. Stand for mains connection cable | 18. Potentiometer |
| 7. Adjustable Handle | 19. Main switch |
| 8. Device Handle | 20. Type plate |
| 9. Welding shoe | 21. Protective tube |
| 10. Jacket heating | 22. Fastening point carabiner power cable |
| 11. Welding rod entry (bilateral) | 23. Guide handle |
| 12. Pre-heating nozzle | 24. Locking screw Guide handle |

Figure 1/Control panel (2)

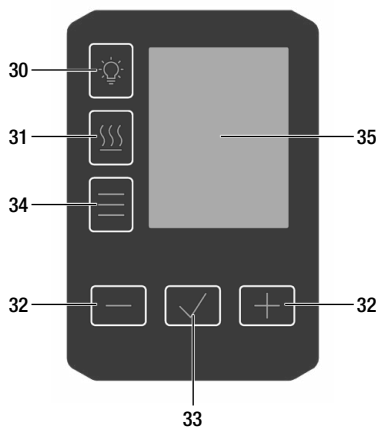

- 30. Button *Work light On/50%/Off*
- 31. Button *Heating On/Off*
- 32. Button *Reduce/Increase*
- 33. Button *Confirm*
- 34. Button *Menu*
- 35. Display

5. Settings on the WELDPLAST 600/605

5.1 Adjusting the handle (7)



Loosen the adjustable handle (7) with a counterclockwise turn. Set the position of the adjustable handle (7) on the protective tube and fasten it again with a clockwise turn of the adjustable handle (7).

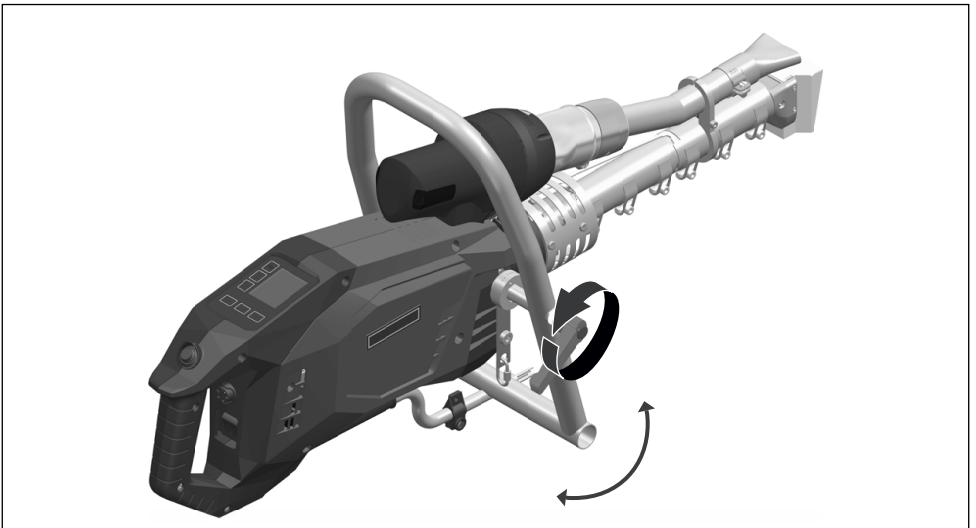

Loosen the locking screw (24), adjust the guide handle (23), tighten the locking screw (24).

6. Commissioning and operation of the WELDPLAST 600/605

6.1 Work environment and safety

Warning



Hazardous voltage, danger to life

There is a danger to life from electric shock due to electrical voltage. The extruder must therefore only be connected to sockets and extension cables with a protective earth conductor. Protect the extruder from moisture and wet conditions. Before starting the device, check the power cord, the plug and the extension cable for electrical and mechanical damage.



Risk of burning

Do not touch exposed metal parts or escaping material while they are hot. The device should always first be allowed to cool down. Never point the hot air flow at people or animals.



Risk of fire and explosion

Caused by improper use of the extruder (e.g., material overheating), and particularly in the vicinity of flammable materials and explosive gases.

Never use the hot air welder extruder in explosive or readily inflammable surroundings. Maintain sufficient distance from combustible materials or explosive gases at all times.

Place the handheld extruder exclusively on fireproof surfaces. Hot metal parts and the warm air jet must be kept at a sufficient distance from the support and walls.

The device must be monitored continuously during operation. Waste heat can come into contact with flammable materials that are not in view.

Caution



Ensure that you are in a stable position while working. The connection cables and welding rod must be able to move freely and must not hinder the user or third parties while working. (Tripping hazard). Comply with national statutory requirements regarding occupational safety (securing personnel or devices).



If the device is being used on construction sites, a fault current circuit breaker must be used to protect site personnel.



The device should only be operated by **trained specialists** or under their supervision. Children are not permitted to operate the device.

Power cord and extension cable

- The nominal voltage specified on the device (see  Technical data [2]) must match the supply voltage.
- The extension cables must be authorized for the utilization site (such as, outdoors) and be marked accordingly. Take the necessary minimum cross-section for extension cables into account. Recommendation at least 2.5 mm².

Power supply with autonomous power generators

- When using autonomous power generators, they must be grounded and equipped with residual current circuit breakers.
To prevent possible damage to the electronics, Leister recommends power generators that have a maximum total harmonic distortion (THD) of 5% or less.
- The formula "2 x nominal power of the hot air extruder" applies to the design of the nominal power of power generators.
- The device may only be switched on and off when the generator is running, otherwise the electronic components may be damaged.
- Disconnect the device from the mains before starting or switching off the generator.

6.2 Prepare device

- Place the hot air welder extruder on a suitable surface so that the device is stable and safe. Make sure that nothing flammable is radiated by the heat of the extruder.
- Check whether the material to be welded is clean.
- Then check whether the **welding shoe (9)** is clean.
- Check the **preheating nozzle (12)** is in the right position and tightened.
- Check the **power cord (1)** and plug for electrical and/or mechanical damage.

6.3 Starting the device



- Once you have prepared the working area and the hot air welder in accordance with the description, connect the hot air welder to the supply voltage.
- Use the **main switch (18)** to switch the hot-air welder extruder on.

After startup, the Start screen will appear briefly in the display with the version number of the current software release and the device designation.

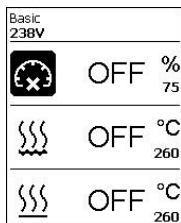

If the device was allowed to cool down beforehand, this will be followed by a static display of the setpoints of the most recently used profile (the Basic profile is displayed when the device is first commissioned).

The heating is not yet switched on at this stage.

- Now select the appropriate welding formula (see 9.3) or set the welding parameters individually.
- Now control the heating with the *Heating On/Off button (31)*.

6.4 Welding sequence

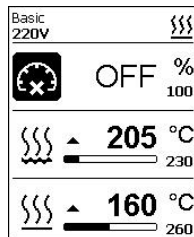

Preparing for welding

As soon as you have switched on the heating (Button 31 *Heating On/Off*), you will see **adynamic display of the current air and plastic temperature with a progress bar** (setpoint and actual values).

The plastic drive is still locked.

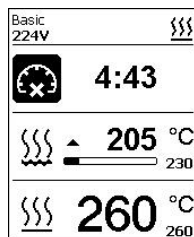

If the ACTUAL temperature of the plastic is 30°C below the DESIRED temperature, the 5-minute timer starts. When the timer has expired, the plastic drive is enabled.

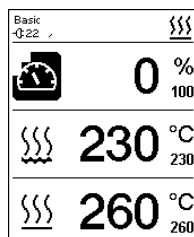

The plastic and air temperatures have now been reached. The plastic drive is enabled.

- Now carry out test welds in accordance with the welding instructions of the material manufacturer and/or national standards or regulations and inspect the results. Adjust the welding profile as required.
- By pressing the **drive on/off switch (16)**, the plastic drive starts extruding the inserted welding rod.
- Extrude some material without welding before the actual welding process.
- **Guide the extruder during the welding process keeping it stable. The preheating nozzle must heat the surfaces to be welded.**
- Never feed the welding rod into both **welding rod insertion points (11)** at the same time. Always operate the extruder with the welding rod.

6.5 Finishing welding

- To stop the plastic output, press the **drive on/off switch (16)**. Slowly swivel the welding shoe away from the welding seam.
- Pull out any material left over in the welding shoe hole.

6.6 Switching off the device/Maintenance

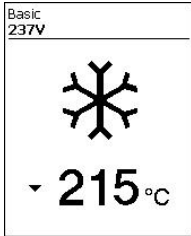

- Cut off the welding rod.
- Pull out any remaining material in the welding shoe hole.

Switch off the air/plastic heaters with the button (31). The cool-down mode is activated.

- Note that the **jacket heater (10)** remains hot for a certain time after the cool-down mode has been completed.
- The blower switches off automatically after approx. 6 minutes.
- Now switch off the device with the **main switch (18)** and disconnect the **power cord (1)** from the electrical network.
- Wait until the device has cooled down fully.
- Check the **power cord (1)** and plug for electrical and/or mechanical damage.

7. Quick Reference Guide WELDPLAST 600/605

7.1 Switching on/Starting

1. Ensure that the **main switch (18)** is switched off and connect the plug from the power cable
2. Switch on the **main switch (18)**.
3. Switch on the heating with the *heating On/Off (31) button*; wait 10 minutes until the desired temperature is reached and the drive is released.
4. Guide the welding rod into the **welding rod entry point (11)** and switch on **the plastic drive (16)** with the drive on/off switch

7.2 Switching off

1. Cut off the welding rod.
2. Clean the opening of the welding shoe when the plastic drive is switched off.
3. Switch off the heating *with the Heating On/Off button (31)* and wait for the cooling process to finish (approx. 5 minutes).
4. **Switch off the main switch (18).** **Caution:** Jacket heating remains hot for some time.
5. Pull out supply voltage plug

LEISTER**WELDPLAST 600/605**
Quick Guide

User Manual:
leister.com/DLP-Weldplast-605

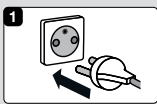
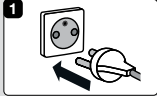

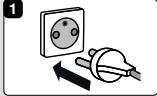
1

2



3

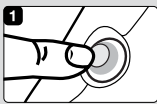
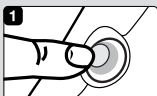

4
10 min

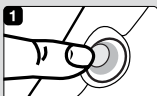

5



1

2

3
6 min

4

5

QG WELDPLAST 600/605 / Art. 170.895 / 06.2021

8. The control panel of the WELDPLAST 600/605

The **control panel (2)** is comprised of the **function buttons** with which you control the various menu functions, and the **display** where the respectively selected setting, menu options or the values valid for the running time are displayed.

8.1 Function buttons

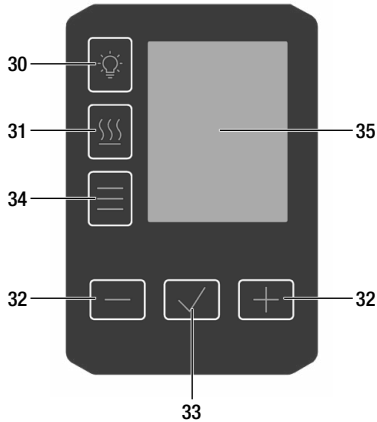

30. Button *Work light On/50%/Off*

31. Button *Heating On/Off*







32. Button *Reduce/Increase*

33. Button *Confirm*

34. Button *Menu*

35. Display

Multiple allocation of function buttons Control panel (2)/Symbols Display

Symbol	Name	In the work display	In the menu, after pressing the button (33)
	Button <i>Work light On/50%/Off (30)</i>		
	Button <i>Heating On/Off (31)</i>		
	Buttons <i>Reducing/increasing (32)</i>		
	Press briefly	Setting the required setpoint in 5°C or 5% steps	Changing the position/ changing the menu, setting parameters
	Press and hold	Fast setting of desired setpoint values	Changing the position/ changing the menu, setting parameters
	Button <i>Confirm (33)</i>	The set value is applied and shown in the Menu selection.	The desired function or menu is executed.
	Button <i>Menu (34)</i>	Switching to the menu area	Back to working display

8.2 Display

The display is subdivided into two display areas:

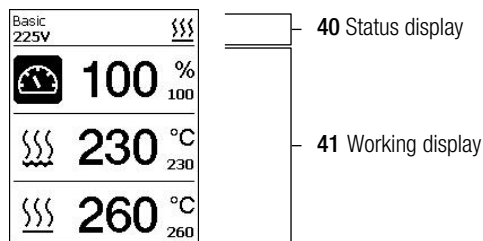

8.3 Setting the welding parameters

To adjust a welding parameter before welding, proceed as follows:

Example for setting the welding temperature

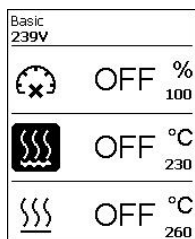
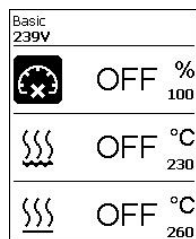

- Press the *Minus button (32)* to select the plastic temperature,
- then press the *Confirm button (33)*.

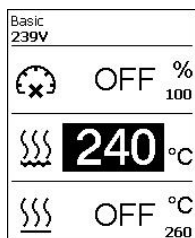
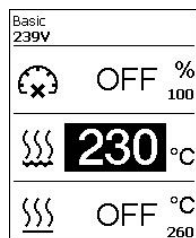

- set the desired target temperature value with the *Minus/Plus buttons (32)*
- cursor automatically jumps back to the temperature symbol
- with the *Minus/Plus buttons (32)* select the next welding parameter

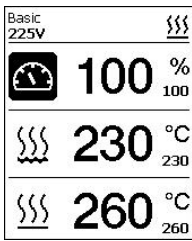

- during the welding process, plastic extrusion can be adjusted at any time using the **potentiometer (18)**
- between 60 and 100% to adjust other parameters during the welding process, press the *Minus/Plus button (32)* to select the parameters to be adjusted

- Press the *Confirm button (33)*
- then set the desired target value with the *Minus/Plus button (32)*
- without further input, the cursor automatically switches back to the temperature symbol

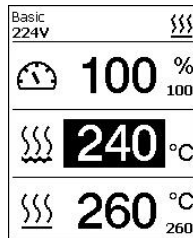
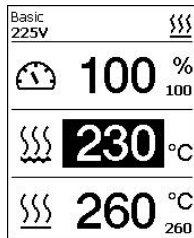
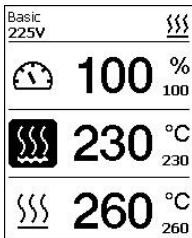

8.4 Display symbols of the status display (Display 40)

The Status display is subdivided into a left-hand (1) and a right-hand area (2).

Status display 1/Left	
Profile name	Displays the name of the selected currently valid welding profile (such as Basic). If a profile name contains more than 6 characters, the first 6 characters are shown first, one after the other, followed by the remaining 6 characters. The system presents the first 6 characters afterwards.
Voltage	Display of the supply voltage
Status display 2/Right	



Warning present



Data recording



Overvoltage



Eco mode



GPS data reception



Undervoltage



WLAN



Stop Device on Alert switched on



Heating

8.5 Display symbols of the work display (Display 35)

Basic 225V	
	100 % 100
	230 °C 230
	260 °C 260

During operation, the setpoints of the welding parameters (ejection in %, temperature in °C or °F, air volume in % and, if necessary, information notes (see Application Mode: Showing current values).

- Change welding parameters by pressing the *Minus/Plus button* (32)
- after pressing the *Confirm button* (33), the selected parameter can be individually adjusted by pressing the *Minus/Plus button* (32)

	Plastic ejection symbol [%]
	Plastic temperature symbol [°C or °F]
	Symbol air temperature [°C or °F]
	Symbol air volume [%]
	<p>Welding temperature too low, heat-up process.</p> <ul style="list-style-type: none"> • Upward arrow and progress bar indicate if higher temperature has not yet been reached • Flashing value over progress bar indicates current actual value (205) • Value to the right of bar (230) indicates setpoint of the selected welding profile or individual setting
	<p>Temperature too high, cool-down process.</p> <ul style="list-style-type: none"> • Down arrow and progress bar indicate that if the desired lower temperature has not yet been reached, the • flashing value above the bar indicates the currently reached actual value (240) • value to the right of the bar (215) indicates the target value of the selected welding profile or individual setting
	Symbol for Cool-down mode
	<p>Symbol for hardware error message</p> <ul style="list-style-type: none"> • Device no longer ready for use • Contact your authorized Leister Service Center (note the respective error code in the section Warning and error messages)
	<p>Symbol for Hardware error message (heating element is defective).</p> <ul style="list-style-type: none"> • Device no longer ready for use • Contact Leister Service Center
	<p>Symbol for Overtemperature warning message.</p> <ul style="list-style-type: none"> • Allow the device to cool down.

9. Settings and functions of the WELDPLAST 600/605 software

9.1 Overview menu navigation basic settings

Pressing the  *Menu button (34)* takes you to the Basic Settings menu items.



From the default setting, use the Settings menus to access formulas, display set-points, Eco Mode, LQS and Advanced Mode.

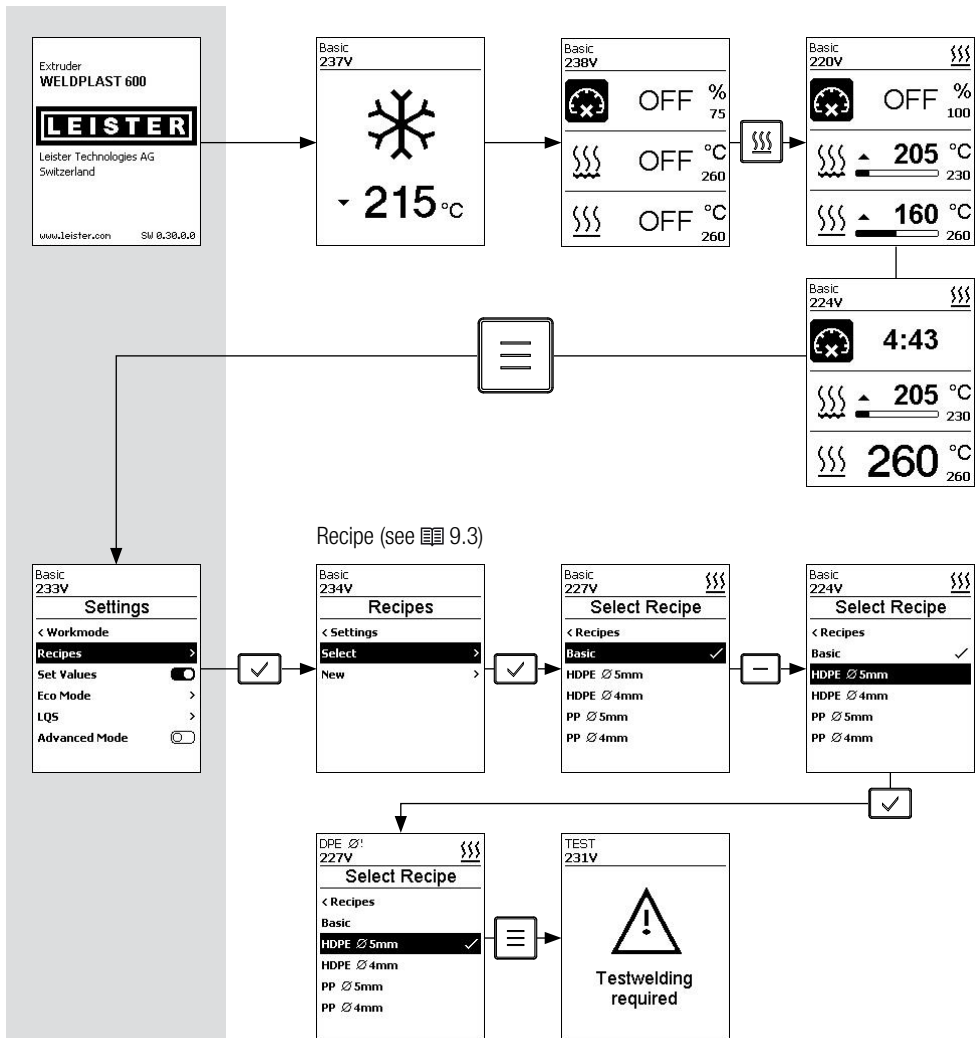

Switching off Target and Actual Value Display (see 9.4)

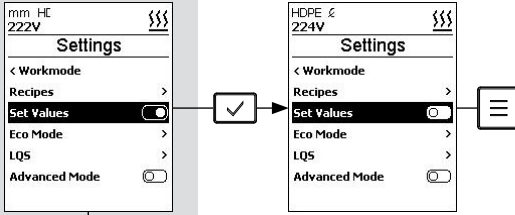

Switching on ECO Mode (see 9.5)

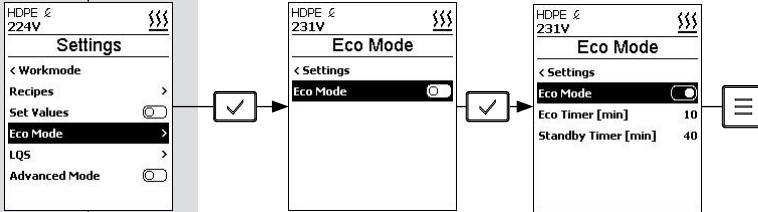

Switching on Data Recording (see 9.6)

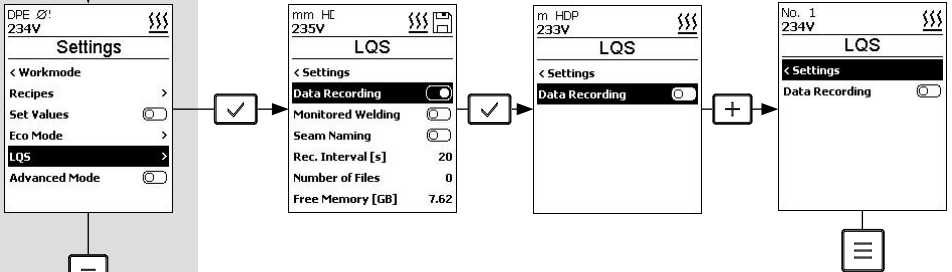

Switching on Advanced Mode

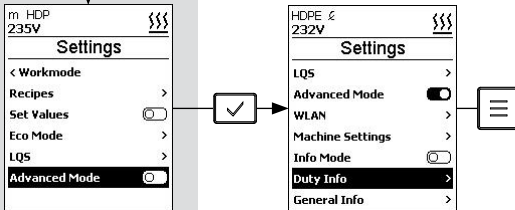

Note: Pressing the  *Menu (34)* button will return you to the working display in each menu item.

9.2 Overview menu navigation Advanced Mode



If you activate Advanced Mode, further information and setting options are available. WLAN, machine settings, info mode, counter, general info, warnings

Switching on Advanced Mode

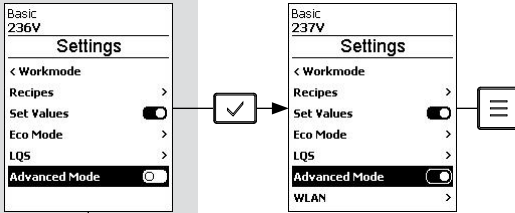

Activate WLAN (see 9.7)

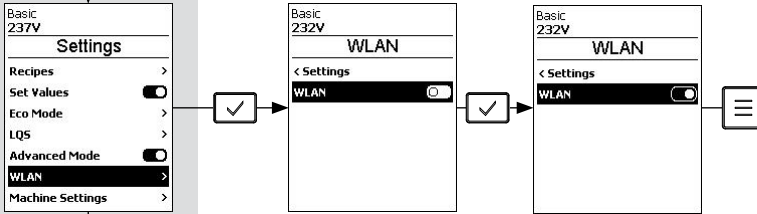

Machine settings (see 9.8)

Example: Setting the time

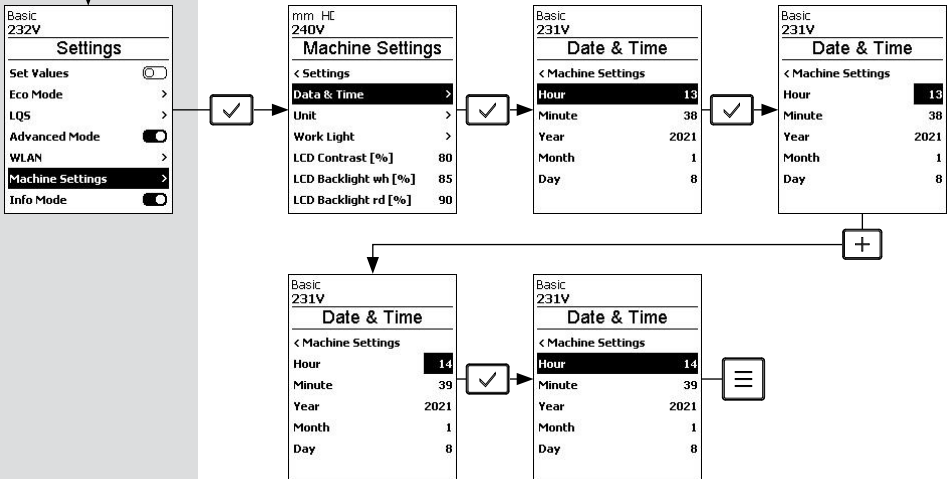

Switching on Info Mode (see 9.9)

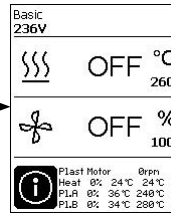
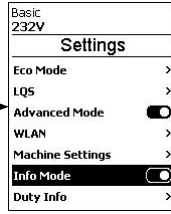

Counter (see 9.10)

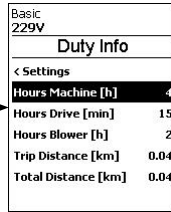

General info (see 9.11)

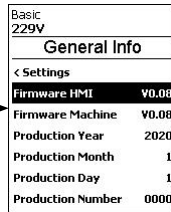

Warnings (see 9.12)

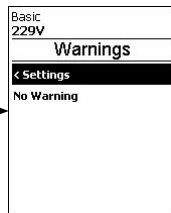

Note: Pressing the  Menu (34) button will return you to the working display in each menu item.

9.3 Recipes

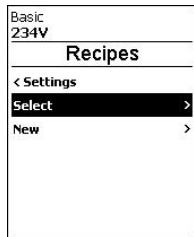

Recipes saved recipes can be found under Select. To select a recipe, press the *Confirm button (33)*.
If no recipes are available, you can create recipes under New.



Use the *Minus/Plus buttons (32)* to select the desired recipe Press the *Confirm button (33)* to accept the recipe Exit the menu by pressing the *Menu button (34)*
Note for test welding appears



You can create a recipe yourself under the New menu item.

To edit a name, press the *Confirm button (33)* with the *Minus/Plus buttons (32)*. Select characters or digits, and use the *Confirm button (33)* to accept. Line change with the *Work light button (30)* or *Heater button (31)* to exit the character editor and save the name check mark and accept with the *Confirm button (33)*.

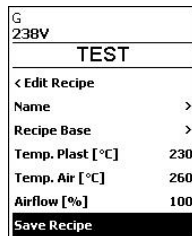
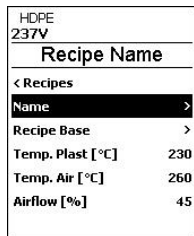

You can adjust the parameters of your own recipes at any time.

To do this, in the menu Recipes select the submenu Edit by pressing the Minus (32) button.

After pressing the Confirm button (33), all editable recipes are displayed.

Use the Minus button (32) to select the recipe to be edited and press the Confirm button (33).

Use the Minus button (32) to select the parameter to be edited and press the Confirm button (33).

You can now set the desired value with the Minus/Plus (32) buttons.

Pressing the Confirm (33) button accepts the set value.

To save the setting, use the Minus button (32), select the Save Recipe menu item, then press the Confirm button (33).

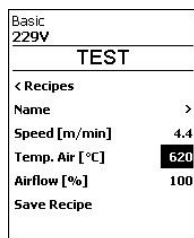
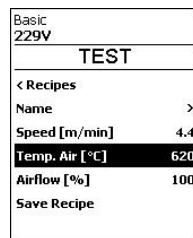
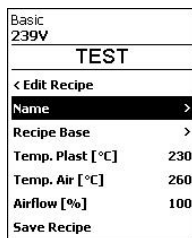

9.4 Displaying nominal values (Set values)

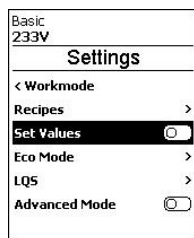

Factory activated

If you do not wish to display the setpoint and actual value on the working display, you can deactivate Set Values by pressing the Confirm (33) button.



If the Set Values function is activated (factory setting), the actual temperature (high) and the target temperature (low) are shown in the work display.

This also applies to plastic extrusion (%) and air volume (%).

9.5 Eco mode

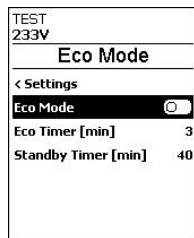

Switched off at the factory

- Enable Eco Mode by pressing the *Confirm button (33)* The
- time interval for the Eco and Standby timer can be individually configured by selecting the value to be edited with the *Minus/Plus (32)* buttons
- after pressing the *Confirm (33)* button, the desired value can be set individually with the *Minus/Plus (32)* buttons
- By pressing the *Confirm (33)* button, the set value is accepted

If Eco mode is activated, the plastic heating is switched on first during the heating up process. The air heater is still switched off. When the plastic heater reaches the ACTUAL temperature of 20°C before the set TARGET temperature, the 5 minute countdown timer of the extruder starts. At the same time, the air heater is switched on. Both heaters are ready for plastic and air until the end of the countdown timer. The air volume is activated as set.

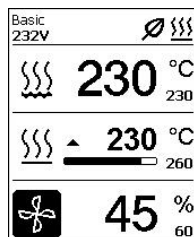

ECO timer

If the extruder remains under the time period specified in the ECO timer when the Eco mode is activated, a change to Eco mode occurs automatically. The air volume is automatically reduced to the minimum and the target air temperature is reduced by 30°C. In the working display, eco mode is displayed with the corresponding symbol.

The operating state can be reactivated at any time with the drive button (17)

or one of the three buttons.

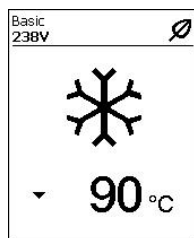

Standby timer

After the standby timer has expired without any activity, the cooling process is initiated. To interrupt the cooling process, press the *Heating On/Off button (31)*.

9.6 LQS Data Recording settings

- In the menu, by pressing *Minus button (32)*, select the menu item LQS,
- then press the *Confirm button (33)*,
- to switch on the data recording, press the *Confirm button (33)*.

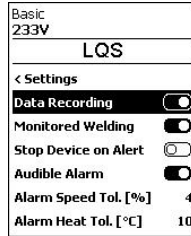
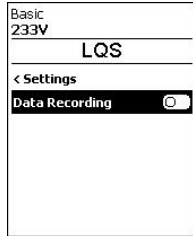

Monitored Welding



- If Monitored Welding is switched on, exceeded limits of the recorded welding parameters are logged.
- In the menu by pressing the *Minus button (32)*, select the Monitored Welding menu item,
- then press the *Confirm button (33)*.

Audible Alarm



- If the Audible Alarm is switched on, an alarm sounds when the limit value is exceeded.
- To activate the Audible Alarm, select the Audible Alarm menu item in the menu by pressing the *Minus button (32)*, then press the *Confirm button (33)*.

- Select the limit value to be set by pressing the *Minus (32) button and then press the Confirm (33) button*.
- Use the *Minus/Plus (32) button* to set the limit value.

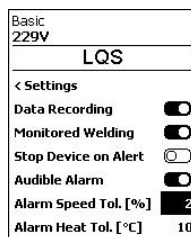

Seam Naming

Basic 236V	
LQS	
Audible Alarm	<input type="checkbox"/>
Alarm Speed Tol. [%]	2
Alarm Plast Tol. [°C]	10
Alarm Heat Tol. [°C]	10
Alarm Vol. Tol. [%]	5
Seam Naming	<input type="checkbox"/>
Rec. Interval [s]	20

Basic 236V	
LQS	
Audible Alarm	<input checked="" type="checkbox"/>
Alarm Speed Tol. [%]	2
Alarm Plast Tol. [°C]	10
Alarm Heat Tol. [°C]	10
Alarm Vol. Tol. [%]	5
Seam Naming	<input checked="" type="checkbox"/>
Seam Name	>

- By pressing the *Minus button (32)*, select Seam Naming, then press the *Confirm button (33)*.

Seam Name

Basic 236V	
LQS	
Alarm Speed Tol. [%]	2
Alarm Plast Tol. [°C]	10
Alarm Heat Tol. [°C]	10
Alarm Vol. Tol. [%]	5
Seam Naming	<input checked="" type="checkbox"/>
Seam Name	>
Rec. Interval [s]	20

Basic 236V	
Seam Name	
< LQS	
Seam Name	>

- By pressing the *Minus button (32)*, select Seam Naming, then press the *Confirm button (33)*.

Basic 230V	
SEAM-1	
1 2 3 4 5 6 7 8 9 0	
Q W E R T Z U I O P	
A S D F G H J K L	
↑ Y X C V B N M ◀	
- ⬅ ➡	
✓	

Basic 236V	
Seam Name	
< LQS	
SEAM-1	>

- To edit the name, press the *Confirm button (33)*
- with the *Minus/Plus buttons (32)* Select characters or digit, then use the *Confirm button (33)*
- to *acceptline change with the Drive button (30) or Heating button (31)*
- to exit the character editor and save the selected name, select the check mark and accept with the *Confirm button (33)*.

Rec. Interval

Basic 232V	
LQS	
Alarm Speed Tol. [%]	4
Alarm Heat Tol. [°C]	10
Alarm Vol. Tol. [%]	5
Seam Naming	<input type="checkbox"/>
Seam Name	>
Rec. Interval [cm]	40
Number of Files	13

Basic 232V	
LQS	
Alarm Speed Tol. [%]	4
Alarm Heat Tol. [°C]	10
Alarm Vol. Tol. [%]	5
Seam Naming	<input checked="" type="checkbox"/>
Seam Name	>
Rec. Interval [cm]	20
Number of Files	13

- By pressing the *Minus button (32)*, select the Rec. menu item Select Interval, then press the *Confirm button (33)*
- with the *Minus/Plus button (32)* Set value for recording interval
- then press the *Confirm button (33)* to accept the set value

Number of Files

Basic 236V	
LQS	
Alarm Heat Tol. [°C]	10
Alarm Vol. Tol. [%]	5
Seam Naming	<input checked="" type="checkbox"/>
Seam Name	>
Rec. Interval [s]	15
Number of Files	0
Free Memory [GB]	7.62

- Select the Number of Files menu item in the menu by pressing the *Minus (32)* button.

The number of recorded files is displayed.

Free memory

Basic 236V	
LQS	
Alarm Vol. Tol. [%]	5
Seam Naming	<input checked="" type="checkbox"/>
Seam Name	>
Rec. Interval [s]	15
Number of Files	0
Free Memory [GB]	7.62
GPS	<input type="checkbox"/>

- Select the *Free Memory* menu item in the menu by pressing the *Minus (32)* button.

The free memory capacity is displayed.

GPS

Basic 236V	
LQS	
Alarm Vol. Tol. [%]	5
Seam Naming	<input checked="" type="checkbox"/>
Seam Name	>
Rec. Interval [s]	15
Number of Files	0
Free Memory [GB]	7.62
GPS	<input type="checkbox"/>

Basic 237V	
LQS	
Seam Naming	<input checked="" type="checkbox"/>
Seam Name	>
Rec. Interval [s]	15
Number of Files	0
Free Memory [GB]	7.62
GPS	<input checked="" type="checkbox"/>
GPS Position	>

Switched off at the factory

- To switch on GPS, select the *GPS* menu item in the menu by pressing the *Minus (32)* button; then press the *Confirm (33)* button.

The GPS coordinates of the welds are now displayed in the welding protocol.

GPS position

Basic 237V	
LQS	
Seam Naming	<input checked="" type="checkbox"/>
Seam Name	>
Rec. Interval [s]	15
Number of Files	0
Free Memory [GB]	7.62
GPS	<input checked="" type="checkbox"/>
GPS Position	>

Basic 235V	
GPS Position	
N 46° 54.8271'	
Longitude	
E 8° 15.5502'	
Elevation	
468.19 m	
Satellites in view	10
HDOP	1.91

- In the menu, by pressing the *Minus button (32)*, select the GPS position menu item, then press the *Confirm button (33)*
- With an existing satellite connection, GPS position data are visible by pressing the *Minus/Plus button (32)*.
- The symbol for GPS reception is displayed in the **status display (40)**.
- If the symbol is filled out in black, satellites were found.
- If the symbol is not filled out, satellites are searched.

9.7 WLAN settings

Switched off at the factory



- Select the *WLAN* menu item in the menu by pressing the *Minus button (32)*, then press the *Confirm button (33)*.

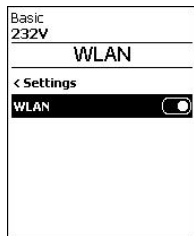
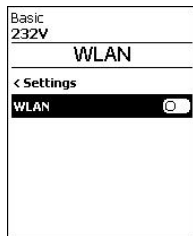

- To switch on the *WLAN*, press *Confirm (33)*

9.8 Machine settings

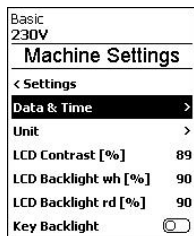

- Select the *Machine Settings* menu item in the menu by pressing the *Minus button (32)*, then press the *Confirm (33) button*

Date and time setting

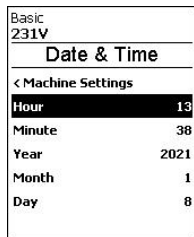
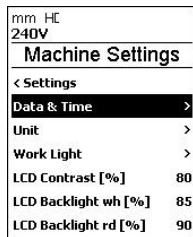

- Select the *Data & Time* menu item in the menu by pressing the *Minus button (32)*, then press the *Confirm button (33)*,
- hour, minute, year, month and day can be set
- with the *Minus/Plus buttons (32)*, select the value to be edited, then press the *Confirm button (33)*, then press the
- desired value with the *Minus/Plus buttons (32)*,
- apply set value by pressing the *Confirm button (33)*

Unit

- Select the Unit menu item in the menu by pressing the *Minus (32)* button. Press the *Confirm button (33)*,
- now select the unit of the display: set the metric or imperial
- value by pressing the *Confirm button (33)*
- to change a unit, select the desired unit with the *Minus button (32)*, then press the *Confirm button (33)*.

Basic 229V
Machine Settings
< Settings
Data & Time >
Unit >
LCD Contrast [%] 89
LCD Backlight wh [%] 90
LCD Backlight rd [%] 90
Key Backlight <input type="checkbox"/>

Basic 230V
Unit
< Machine Settings
Global Unit imperial
Unit Speed imperial
Unit Heat imperial

Basic 230V
Unit
< Machine Settings
Global Unit metric
Unit Speed metric
Unit Heat metric

Worklight

- To switch on work light, select the Work Light menu item in the menu by pressing the *Minus (32)* button; then press the *Confirm (33)* button.
- Select Switch on work light: Select Motor Release, Always ON or Always OFF
- then with the *Minus button (32)* select the desired unit, then press the *Confirm button (33)*
- with the *Minus/Plus button (32)* Set the intensity of the working light in %
- by pressing the *Confirm button (33)*, accept the set value

DPE Ø! 237V
Machine Settings
< Settings
Data & Time >
Unit >
Work Light >
LCD Contrast [%] 80
LCD Backlight wh [%] 85
LCD Backlight rd [%] 90

E Ø5rr 238V
Work Light
< Machine Settings
Motor Release ✓
Always ON
Always OFF
Brightness [%] 100

HDPE & 237V
Work Light
< Machine Settings
Motor Release ✓
Always ON
Always OFF
Brightness [%] 100

LCD Contrast

mm HC 237V
Machine Settings
< Settings
Data & Time >
Unit >
Work Light >
LCD Contrast [%] 80
LCD Backlight wh [%] 85
LCD Backlight rd [%] 90

- Select the LCD Contrast menu item in the menu by pressing the *Minus button (32)*, then press the *Confirm button (33)*,
- press the *Minus/Plus button (32)*, the contrast can be set
- by pressing the *Confirm button (33)*, then accept the set value

LCD Backlight wh

E 05r 237V	
Machine Settings	
< Settings	
Data & Time	>
Unit	>
Work Light	>
LCD Contrast [%]	80
LCD Backlight wh [%]	85
LCD Backlight rd [%]	90

- Select the LCD contrast menu item in the menu by pressing the *Minus button* (32), then press the *Confirm button* (33),
- press the *Minus/Plus button* (32), the contrast can be set
- by pressing the *Confirm button* (33), then accept the set value

LCD Backlight rd

mm Hc 237V	
Machine Settings	
Data & Time >	
Unit >	
Work Light >	
LCD Contrast [%]	80
LCD Backlight wh [%]	85
LCD Backlight rd [%]	90
Key Backlight	<input checked="" type="checkbox"/>

- Select the LCD contrast rd menu item in the menu by pressing the *Minus button* (32), then press the *Confirm button* (33),
- press the *Minus/Plus button* (32), the contrast can be set
- by pressing the *Confirm button* (33), then accept the set value

Backlight button

5mm f 236V	
Machine Settings	
Unit >	
Work Light >	
LCD Contrast [%]	80
LCD Backlight wh [%]	85
LCD Backlight rd [%]	90
Key Backlight	<input checked="" type="checkbox"/>
Remote Mode	<input type="checkbox"/>

HDPE 237V	
Machine Settings	
Unit >	
Work Light >	
LCD Contrast [%]	80
LCD Backlight wh [%]	85
LCD Backlight rd [%]	90
Key Backlight	<input checked="" type="checkbox"/>
Remote Mode	<input type="checkbox"/>

- In the menu, by pressing the *Minus button* (32), select the Backlight button menu item
- by pressing the *Confirm button* (33) Turn the keyboard lighting on or off.

Service Intvl. (h)

- In the menu, by pressing the *Minus button (32)*, select the menu item Service Intvl. (h).
- then press the *Confirm button (33)* and the *Plus button (32)*,
- then press the *Menu button (34)*, reset the hour counter for the Maintenance Servicing display to 0

Basic 240V	
Machine Settings	
Work Light	>
LCD Contrast [%]	90
LCD Backlight wh [%]	85
LCD Backlight rd [%]	90
Key Backlight	<input type="checkbox"/>
Service Intvl. [h]	0
Remote Mode	<input type="checkbox"/>

Basic 240V	
Machine Settings	
Work Light	>
LCD Contrast [%]	90
LCD Backlight wh [%]	85
LCD Backlight rd [%]	90
Key Backlight	<input type="checkbox"/>
Service Intvl. [h]	<input checked="" type="checkbox"/>
Remote Mode	<input type="checkbox"/>

Basic 239V	
Machine Settings	
Work Light	>
LCD Contrast [%]	90
LCD Backlight wh [%]	85
LCD Backlight rd [%]	90
Key Backlight	<input type="checkbox"/>
Service Intvl. [h]	<input checked="" type="checkbox"/>
Remote Mode	<input type="checkbox"/>

Remote mode

Remote mode is currently inactive.

Reset to defaults



- In the menu, by pressing the *Minus button (32)*, select the Reset to defaults menu item.
- Then press the *Confirm button (33)* and the *Plus button (32)*
- and then press the *Confirm button (33)* to reset all settings to the factory settings.

Basic 240V	
Machine Settings	
LCD Contrast [%]	90
LCD Backlight wh [%]	85
LCD Backlight rd [%]	90
Key Backlight	<input type="checkbox"/>
Service Intvl. [h]	0
Remote Mode	<input type="checkbox"/>
Reset to defaults	<input checked="" type="checkbox"/>

Basic 241V	
Machine Settings	
LCD Contrast [%]	90
LCD Backlight wh [%]	85
LCD Backlight rd [%]	90
Key Backlight	<input type="checkbox"/>
Service Intvl. [h]	0
Remote Mode	<input type="checkbox"/>
Reset to defaults	<input checked="" type="checkbox"/>

Basic 241V	
Machine Settings	
LCD Contrast [%]	90
LCD Backlight wh [%]	85
LCD Backlight rd [%]	90
Key Backlight	<input type="checkbox"/>
Service Intvl. [h]	0
Remote Mode	<input type="checkbox"/>
Reset to defaults	<input checked="" type="checkbox"/>

9.9 Info Mode

Basic 236V									
	OFF °C 260								
	OFF % 100								
	<table border="0"> <tr> <td>Plast Motor</td> <td>0rpm</td> </tr> <tr> <td>Heat</td> <td>0% 24°C 24°C</td> </tr> <tr> <td>PLA</td> <td>0% 36°C 240°C</td> </tr> <tr> <td>PLB</td> <td>0% 34°C 230°C</td> </tr> </table>	Plast Motor	0rpm	Heat	0% 24°C 24°C	PLA	0% 36°C 240°C	PLB	0% 34°C 230°C
Plast Motor	0rpm								
Heat	0% 24°C 24°C								
PLA	0% 36°C 240°C								
PLB	0% 34°C 230°C								

Switched off at the factory

- If Info Mode is activated, additional information is displayed at the work level.

The following information is displayed:

- Speed plastic motor in rpm
- Blower heating; capacity of heating output in % as well as ACTUAL and TARGET temperature in °C
- Heating plastic A; capacity of heating output in % as well as ACTUAL and TARGET temperature in °C
- Heating plastic B; capacity utilization in % as well as ACTUAL and TARGET temperature in °C

Basic 231V	
Settings	
Eco Mode	>
LQS	>
Advanced Mode	<input type="checkbox"/>
WLAN	>
Machine Settings	>
Info Mode	<input type="checkbox"/>
Duty Info	>

Basic 232V	
Settings	
Eco Mode	>
LQS	>
Advanced Mode	<input checked="" type="checkbox"/>
WLAN	>
Machine Settings	>
Info Mode	<input checked="" type="checkbox"/>
Duty Info	>

- In the menu by pressing the *Minus button (32)* Select Info Mode menu item
- by subsequently pressing the *Confirm button (33)*, activate Info Mode.

9.10 Duty Info

Basic 231V	
Settings	
LQS	>
Advanced Mode	<input checked="" type="checkbox"/>
WLAN	>
Machine Settings	>
Info Mode	<input checked="" type="checkbox"/>
Duty Info	>
General Info	>

Basic 235V	
Duty Info	
< Settings	
Hours Machine [h]	7
Hours Drive [min]	10
Hours Blower [h]	55

- Select the *Duty Info* menu item in the menu by pressing the *Minus button (32)*, then press the *Confirm (33) button*

The runtimes of the machine, the drive and the blower are displayed.

9.11 General Info

Basic 232V	
Settings	
Advanced Mode	<input checked="" type="checkbox"/>
WLAN	>
Machine Settings	>
Info Mode	<input checked="" type="checkbox"/>
Duty Info	>
General Info	>
Warnings	>

Basic 229V	
General Info	
< Settings	
Firmware HMI	V0.08
Firmware Machine	V0.08
Production Year	2020
Production Month	1
Production Day	1
Production Number	0000

- Select the *General Info* menu item in the menu by pressing the *Minus button (32)*, then press the *Confirm (33) button*

The following information is displayed:

- Software version HMI and PCU
- production date of the extruder
- serial number

9.12 Warnings and error messages

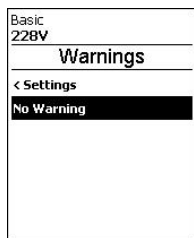
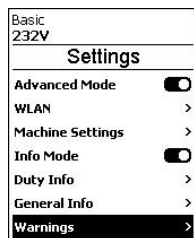

- Select the Warnings menu item in the menu by pressing the *Minus button (32)*, then press the *Confirm (33) button*



All warnings are now displayed.

In the case of a warning, you can continue to work without restriction.

In contrast to the warning message, it is **not possible to continue working once an error message has appeared**. The heating is switched off automatically and the drive is blocked. The display of the corresponding error codes proceeds without delay in the working display.

Specific information regarding the type of error or the warning can be called up at any time, including via the menu Settings under Show Warnings.

Message type	Display	Error code	Description and measures
Warning		---	<p>Example warning symbol in the Status display (40)</p> <p>Supply voltage too high. At the same time, the red backlight of the LCD module is switched on alternately</p>
Error		0008	<p>Error symbol and text of note (Error No. 0008/Excessive temperature) in the work display.</p> <p>Solution: Let the device cool down</p>
		0020	<p>Error symbol and text of note (Error No. 0020/Heating element defective) in the work display.</p> <p>Solution: Replace the heating element</p>

Error (with address of Leister Service Center as needed)*	Basic 162V 	0002	Undervoltage/overvoltage
	 Error No.0002	0004	Hardware error
		0008	Thermoelement is defective
		0100	Blower is faulty
		0200	Communication module error
	Basic 232V	0400	Drive error
	 Error No.0100 Contact your service center www.leister.com		

***Contact Leister Service Center**

10. Accessories

Use only original Leister spare parts and accessories; otherwise, any warranty or guarantee claims will be invalidated.

You can find more information at www.leister.com.

11. Maintenance



Disconnect the device from the power supply and allow to cool before carrying out any maintenance or repair work.

11.1 Lubrication axial groove ball bearing

Basic
239V



Maintenance
Servicing

After 500h operation of the drive motor, the message Maintenance Servicing appears on the **control panel (2)**.

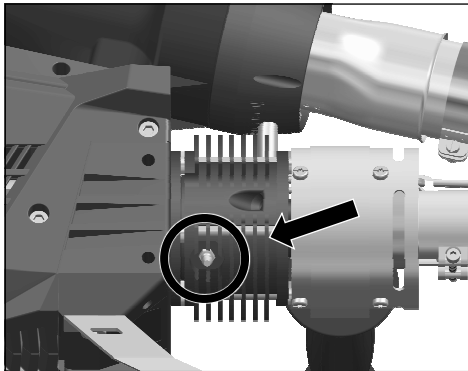

The axial grooved ball bearing must be relubricated every 500 h.
When the drive is running, re-lubricate a maximum of 1 cm³ grease quantity using a grease gun.

Resetting the service message: See  section 9.8
Machine settings

11.2 Cleaning the filters (16)

The **filters (16)** should be cleaned once a week with the brush.

12. Service and repair

Repairs shall be performed exclusively by authorized Leister Service Centers.

Leister Service Centers guarantee a professional and reliable repair service within 24 hours with original spare parts in accordance with circuit diagrams and spare parts lists.

You can find more information at www.leister.com.

13. Training

Leister Technologies AG and its authorized Service Centers offer welding courses and introductory training classes.

You can find more information at www.leister.com.

14. Declaration of Conformity

EU Declaration of Conformity

Leister Technologies AG, Galileo-Strasse 10, 6056 Kaegiswil, Switzerland confirms that this product fulfills the requirements of the following EU Directives in the models that we have made available for purchase.

Directives: 2006/42/EC, 2014/30/EU, 2014/53/EU, 2011/65/EU

Harmonized EN ISO 12100, EN 60335-1, EN 60335-2-45, EN 55014-1, EN 55014-2,

Standards: EN 61000-3-2, EN 61000-3-3, EN 61000-6-2, EN IEC 63000

Kaegiswil, 01/27/2022

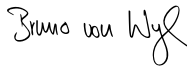

Bruno von Wyl, CTO



Christoph Baumgartner, GM

UK Declaration of Conformity

Leister Technologies AG, Galileo-Strasse 10, 6056 Kaegiswil, Switzerland confirms that these products, in the versions as brought into circulation through us, fulfil the requirements of the following UK Statutory Instruments.

UK Statutory Instruments: 2008 No. 1597, 2017 No. 1206, 2012 No. 3032

Designated EN ISO 12100, EN 60204-1, EN 55014-1, EN 55014-2, EN 61000-3-2,

Standards: EN 61000-3-3, EN 61000-6-2, EN 62233, EN 60335-1, EN 60335-2-45, EN IEC 63000, ETSI EN 300 328 V2.2.2

Kaegiswil, 01/27/2022

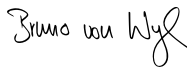

Bruno von Wyl, CTO



Christoph Baumgartner, GM

15. Disposal



Do not dispose of electrical equipment with household refuse!

Electrical equipment, accessories and packaging should be recycled in an environmentally friendly manner. When you are disposing of our products, please observe the national and local regulations.

Warranty

- The guarantee or warranty rights granted for this device by the direct distribution partner/salesperson apply from the date of purchase.
- In the event of a guarantee or warranty claim (verification by invoice or delivery note), manufacturing or processing errors will be rectified by the sales partner through replacement delivery or repair.
- Other guarantee or warranty claims are excluded within the framework of mandatory law.
- Damage resulting from natural wear, overload, or improper handling is excluded from the warranty.
- Heating elements are excluded from warranty obligations or guarantees.
- Guarantee or warranty claims cannot be asserted for devices that have been converted or changed by the purchaser or for which non-original Leister spare parts have been used.

↳ Sales and service center

Leister Technologies AG
Galileo-Strasse 10
6056 Kaegiswil/Switzerland
Tel. +41 41 662 74 74
Fax +41 41 662 74 16
www.leister.com
sales@leister.com