

LEISTER®

English

VACUUM PLATE 100-LP



Leister Technologies AG

Galileo-Strasse 10

6056 Kaegiswil

Switzerland

+41 41 662 74 74

leister@leister.com

leister.com

Table of Contents

1. Important safety instructions	3
1.1 Warning	3
1.2 Caution	4
1.3 Using and handling the cordless tool	4
1.4 Service	4
2. Application	5
2.1 Intended use	5
2.2 Non-intended use	5
2.3 Misapplication	5
3. Technical data	6
4. Transport	7
5. Your VACUUM PLATE 100-LP	8
5.1 Type plate and identification	8
5.2 Scope of delivery (standard equipment in the case)	8
5.3 Overview of device parts	9
6. Commissioning your VACUUM PLATE 100-LP	10
6.1 Work environment and safety	10
6.2 Preparation and commissioning	11
6.3 Test with VACUUM PLATE 100-LP	11
7. Charger and battery	12
7.1 GAL 18V-40 charger	12
7.2 ProCORE 18V 4.0 Ah / CORE 18V 4.0 Ah battery	13
8. Frequently asked questions, causes and actions VACUUM PLATE 100-LP	14
9. Maintenance	14
9.1 General maintenance instructions for the VACUUM PLATE 100-LP	14
10. Service and repair	15
11. Disposal	15
12. Other applicable documents	15
13. Declaration of Conformity	16

Congratulations on purchasing your VACUUM PLATE 100-LP.

You have chosen a first-class vacuum testing device.

It was developed and produced in accordance with the latest technology in the plastics-processing industry.

It has also been manufactured using high-quality materials.



Please always store these operating instructions with the device.

VACUUM PLATE 100-LP

Testing device



For more information about the VACUUM PLATE 100-LP and specific instructions in the corresponding manuals for the charger and battery, visit leister.com

1. Important safety instructions

1.1 Warning



Risk of electric shock due to electrical voltage

- Protect the device from moisture and wet conditions.
- Remove the battery from the device before opening.



Risk of fire and explosion in case of improper use

- Never place the device near explosive gases.
- Never place the device close to explosive gases while it is running.



Risk to health due to leak detection agent

- Ensure adequate ventilation in the work area to minimize vapor concentration.
- Read the manufacturer's safety data sheet carefully before using a leak detector.



Risk of slipping due to leak detection agent

- Be aware of the increased risk of slipping due to leak detection agents.
- Keep an eye on the temperature: leak detection agents can freeze and lead to ice formation.



Risk of injury due to ejected particles

- The blower can suck in and eject dust particles.
- Clean the membrane in the test area.
- The device must only be operated with the suction filter installed.

1.2 Caution



- The device should only be operated by trained specialists or under their supervision.
- Children are not permitted to operate the device.



- Carefully observe all national regulations relevant to your specific activity in order to ensure safety and legally compliant operation.

1.3 Using and handling the cordless tool

- Only charge the batteries with chargers recommended by the manufacturer.** A charger suitable for a certain type of battery poses a fire hazard if used with other batteries.
- Only use rechargeable batteries in the power tools that are intended for this purpose.** The use of other batteries can lead to injuries and fire hazards.
- Keep unused batteries away from paper clips, coins, keys, nails, screws or other small metal objects that could bridge the contacts.** A short circuit between the battery contacts can result in burns or fire.
- If used incorrectly, liquid may escape from the battery. Avoid contact with this. In case of accidental contact, rinse with water. If the liquid gets into your eyes, seek additional medical help.** Leaking battery fluid can lead to skin irritation or burns.
- Do not use damaged or modified batteries.** Damaged or modified batteries can behave unpredictably and lead to fire, explosion and risk of injury.
- Protect the battery from heat, e. g. continuous exposure to sunlight, fire, dirt, water and moisture. There is a risk of explosion and short circuit.**
- Follow all charging instructions. Never charge the battery or battery tool beyond the temperature range specified in the operating instructions.** Incorrect charging or charging beyond the permitted temperature range may destroy the battery and increase the risk of fire.

1.4 Service

- Your power tool must only be repaired by qualified specialists using only original spare parts.** This ensures that the safety of the power tool is maintained.
- Never repair damaged batteries.** All battery maintenance should only be carried out by the manufacturer or authorized service centers.

2. Application

2.1 Intended use

The VACUUM PLATE 100-LP is intended for professional use and is used to check the weld seams for leaks.

Die VACUUM PLATE 100-LP is intended for use on flat and pitched roofs, in horticulture and in the swimming pool construction sector.

The VACUUM PLATE 100-LP is intended for generating a vacuum in interval operation for a maximum of 2 minutes ON/30 seconds OFF.

Material types and thicknesses

The VACUUM PLATE 100-LP can be used for testing various types of material such as HD-PE, LD-PE, PVC and TPO. The permissible material thicknesses of the indicated materials are 0.5–3 mm. The user must carry out clarifications and assessments regarding other materials and material thicknesses as part of the test.

Use only original Leister spare parts and accessories; otherwise, any warranty or guarantee claims will be invalidated.









2.2 Non-intended use

Any other use or any use beyond the type of use described is deemed non-intended use.

2.3 Misapplication

Never use the VACUUM PLATE 100-LP as a lifting tool, e.g. for lifting plates, disks or similar.

3. Technical data

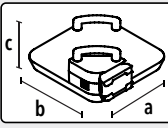
		VACUUM PLATE 100-LP	
	Li-Ion battery capacity	Ah	4
	Battery voltage	V	18
	Charging time (battery)	min	max. 65
	Idle speed	Rpm	39700
	Noise level	dB (A)	78 (K = 3)
	Test pressure	mbar psi	-20 -0.3
	Recommended ambient temperature for charging	°C °F	0...+35 +32...+95
	Permissible ambient temperature during operation and storage	°C °F	-20...+50 -4...+122
Compatibility			
	Compatible batteries		GBA 18V... ProCORE 18V... CORE 18V...
	Compatible chargers		GAL 18... GAX 18... GAL 36...
	Weight (incl. battery)	kg lbs	2 4.4
Dimensions			
	a)	mm inch	320 (360) 12.6 (14.2)
	b)	mm inch	320 12.6
	c)	mm inch	155 6.1

We reserve the right to make technical changes.

4. Transport

Use only the transport box included in the scope of delivery (see scope of delivery) and the handle fitted on the transport box for transporting the VACUUM PLATE 100-LP.



When transporting the device, store and secure it in a way that prevents any mechanical damage. The device must always be stored in the transport box, otherwise the **sealing lip (5)** can become permanently deformed.



The spare battery must always be stowed in the transport box with the contacts facing downwards. In general, unused batteries must be stored in the transport box. **Keep unused batteries away from paper clips, coins, keys, nails, screws or other small metal objects that could bridge the contacts. Do not ship/transport defective batteries.** A short circuit between the battery contacts can result in burns or fire.

To lift the VACUUM PLATE 100-LP by hand, use the **carrying handles (6)**.

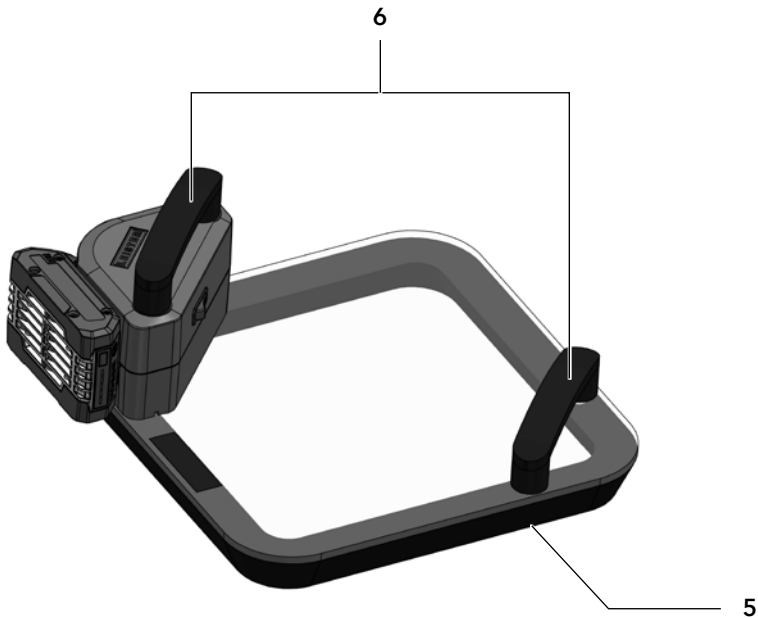

5. Your VACUUM PLATE 100-LP

5.1 Type plate and identification

The model and serial number are indicated on your device's **name plate (9)**.

Transfer this information to your operating instructions; in the event of any inquiries to our country subsidiary or your authorized Leister sales and service partner, please always refer to this information.

Model:

Serial no.:

Example:



5.2 Scope of delivery (standard equipment in the case)

VACUUM PLATE 100-LP version, without battery, without charger:

- 1 × VACUUM PLATE 100-LP device
- 1 x VACUUM PLATE 100-LP safety instructions
- 1 × Original Quick Guide
- 1 × AMPShare Akku safety instructions
- 1 × GAL 18V-40 operating instructions
- 1 × AMPShare manufacturer's warranty

Also available in VACUUM PLATE 100-LP, 18.0V/4.0Ah:

- 2 × AMPShare 18.0V/4.0Ah batteries
- 1 × GAL 18V-40 charger

5.3 Overview of device parts

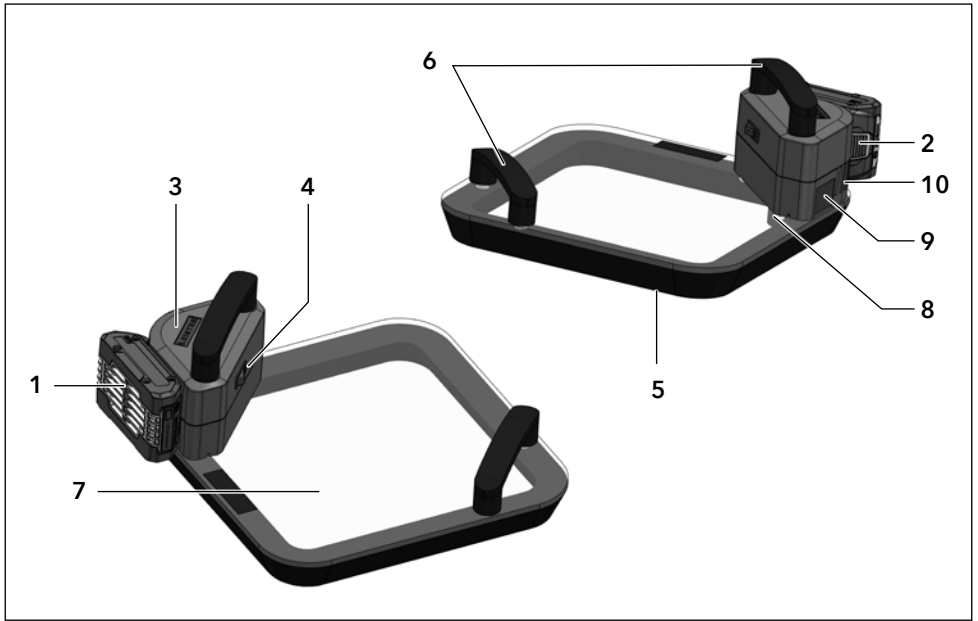

- | | |
|--------------------------------|---|
| 1. Battery | 6. Carrying handles |
| 2. Battery release button | 7. Viewing window |
| 3. Housing | 8. Inlet filter |
| 4. Main switch (On/Off switch) | 9. Type plate with model designation and series marking |
| 5. Sealing lip | 10. Air outlet |

6. Commissioning your VACUUM PLATE 100-LP

6.1 Work environment and safety

Warning message



Risk of electric shock due to electrical voltage

- If the housing is damaged, the battery must be disconnected from the VACUUM PLATE 100-LP immediately.
- Keep the device away from moisture and wet conditions.



Danger of fire and explosion with improper use in the vicinity of explosive gases

- Admixtures (e.g. combustible or explosive gases or vapors), traces of oil, oil vapor, grease and dust must not be sucked in.
- Any operation in a potentially explosive environment is prohibited.



Risk to health due to leak detection agent

- Ensure adequate ventilation in the work area to minimize vapor concentration.
- Read the manufacturer's safety data sheet carefully before using a leak detector.



Risk of slipping due to leak detection agent

- Be aware of the increased risk of slipping due to leak detection agents.
- Keep an eye on the temperature: leak detection agents can freeze and lead to ice formation.



Risk of injury due to ejected particles

The blower can suck in and eject dust particles.

- Clean the membrane in the test area.
- The device must only be operated with the suction filter installed.



Risk of burns due to overheating of the fan

- The device may only be operated at intervals.
- The on-time must be kept <2 min.
- Always allow the device to cool down.
- The VACUUM PLATE 100-LP can only be operated using the handles and switches provided.

6.2 Preparation and commissioning

- Check the VACUUM PLATE 100-LP for any damage, e.g. cracks, fissures or scratches, before each use.
- **Inlet and outlet openings (8, 10)** must be open at all times for air to be drawn in and discharged unhindered.
- Check the condition of the **sealing lip (5)** for damage.
- Caution: Excessive damage to the **sealing lip (5)** may prevent the required test pressure from being reached.
- **Insert the battery (1)** into the VACUUM PLATE 100-LP.

6.3 Test with VACUUM PLATE 100-LP

- The welding area must be free of contamination. Dirt particles may compromise the test.
- The seam area to be inspected must be sprayed with a leak detection agent (e.g. soapy water) directly before the inspection. The liquid must not damage the seam and the weld material.
- Position the VACUUM PLATE 100-LP at the point to be tested.
- Position and press on the VACUUM PLATE 100-LP so that the area to be tested is approximately in the center of the field of vision of the testing device. For longer test sections, the VACUUM PLATE 100-LP needs to be repositioned accordingly.
- Lightly press the VACUUM PLATE 100-LP using both **handles (6)** onto the area to be tested.
- Switch on the **main switch (4)** of the VACUUM PLATE 100-LP to generate negative pressure.
- Visual inspection of the weld seam for leaks
- The seam is considered tight if no bubbles occur.
- Switch off the device using the **main switch (4)** and allow to cool down.
- Mark and repair areas that are not tight

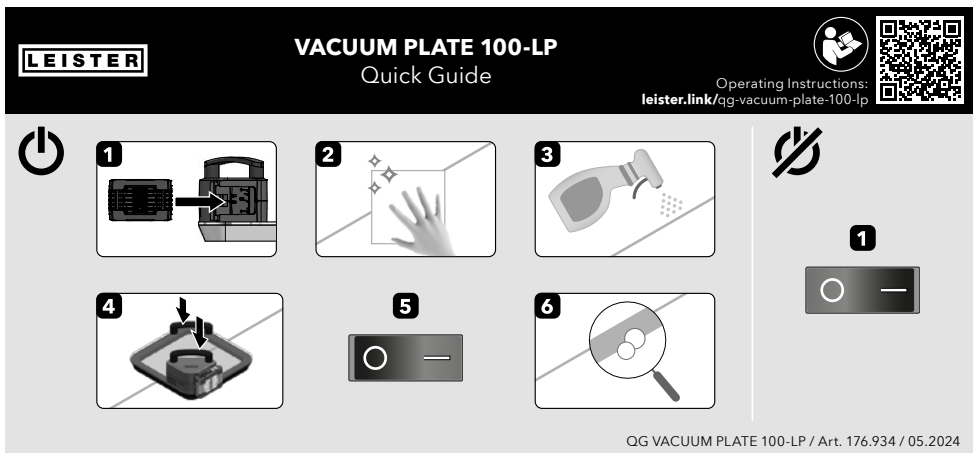

7. Charger and battery

General safety instructions for power tools – observe the instructions for use and handling of the cordless tool in Section 1.3.

The VACUUM PLATE 100-LP is designed for use with the ProCORE 18V 4Ah or CORE 18V 4Ah battery and the GAL 18V-40 charger.

Keep the charger away from rain and moisture. Chargers exposed to water increase the risk of electric shock.



Read operating instructions

Specific instructions on the use of the battery and charger can be found in the relevant documents: AMPShare battery safety instructions, GAL 18V-40 operating instructions and AMPShare manufacturer's warranty. Read these documents before first use.

7.1 GAL 18V-40 charger

The GAL 18V-40 charger is designed for charging Li-ion batteries of the ProCORE 18V or CORE 18V type.

Safety Instructions



Read all safety information and instructions. Failure to observe the safety information and instructions may result in electric shock, fire and/or serious injury.

Keep these instructions in a safe place. Only use the charger if you are fully aware of all the functions and can perform them unrestricted or have received appropriate instructions.

Charging process

- Note the mains voltage! The voltage of the power source must match the specifications on the charger's rating plate.
- The charging process starts as soon as the mains plug of the charger is plugged into the socket and the battery is inserted into the charging slot.



Charging is only possible if the temperature of the battery is within the permitted charging temperature range (0–45 °C).

7.2 ProCORE 18V 4.0 Ah / CORE 18V 4.0 Ah battery

The following instructions apply to Bosch Li-ion batteries or those from AMPShare partners.

Safety Instructions



Read all safety information and instructions. Failure to observe the safety information and instructions may result in electric shock, fire and/or serious injury.
Keep all safety information and instructions for future reference.

Inserting the battery

Push the charged battery into the battery holder until it clicks into place.

Removing the battery

To remove the battery, press the battery release button and pull out the battery. **Do not apply any force.**

The battery has two locking stages to prevent the battery falling out if the battery release button is pressed accidentally.

Battery charge level indicator

The green LEDs on the battery charge level indicator show the charge state of the battery. For safety reasons, the charge status can only be queried when the VACUUM PLATE 100-LP is at a standstill.

Press the charge level indicator button  to display the charge level. This is also possible with the battery removed. If no LED lights up after pressing the button for the charge status display, the battery is defective and must be replaced.

Battery type ProCORE 18V...



LED	Capacity
Continuous light 5 × green	80–100 %
Continuous light 4 × green	60–80 %
Continuous light 3 × green	40–60 %
Continuous light 2 × green	20–40 %
Continuous light 1 × green	5–20 %
Flashing light 1 x green	0–5 %

8. Frequently asked questions, causes and actions VACUUM PLATE 100-LP

Do not allow test pressure to build up

- Check the flatness of the membrane while pressing the VACUUM PLATE 100-LP. The VACUUM PLATE 100-LP can compensate an unevenness of approx. 10 mm via the **sealing lip (5)**. There is a risk of leakage if there is a higher level of unevenness.
- Check whether the **sealing lip (5)** is damaged. If the sealing lip is damaged, there is a risk of leakage.

Inlet and outlet openings (8, 10) blocked

- Clean the outlet opening with a brush with plastic bristles. Remove the inlet filter and clean it with a brush with plastic bristles.

9. Maintenance

9.1 General maintenance instructions for the VACUUM PLATE 100-LP



Risk of electric shock due to electrical voltage

- Remove the battery from the device before opening.



Do not bring the device into contact with **aggressive substances** (e.g. acetone, diluent, etc.). There is a risk of damage to the installed **components**.

- Keep the appliance clean.
- Clean cloths must be used to clean the device.
- Only use original Leister accessories.
- Repairs must only be carried out by authorized Leister service centers.
- Leister Service Centers guarantee a professional and reliable repair service within 24 hours with original spare parts in accordance with circuit diagrams and spare parts lists.

For more information please visit leister.com

Recommended maintenance intervals for the device:

Period of time (operating hours)	Monitoring and maintenance work	Spare parts	Tools
After each use of the device	Visual inspection of the sealing lip for damage	–	
After each use of the device	Cleaning the sight glass	–	Water, clean cloth
Daily	Visual check for the presence of the inlet filter	–	
Daily	Visual check of the inlet and outlet openings for soiling Clean dirt with a brush with plastic bristles	–	Brush with plastic bristles

10. Service and repair

Repairs shall be performed exclusively by authorized Leister sales and service partners. You will find the address of your authorized Leister sales and service partner on the last page of these operating instructions.

For more information please visit leister.com.

Note



- Do not loosen the screws on the motor housing during warranty period. Failure to do so will invalidate the manufacturer's warranty obligations.
- When shipping the battery, take care to ensure correct declaration (hazardous goods).

11. Disposal



Do not dispose of electrical equipment with household refuse!

Electrical equipment, accessories and packaging should be recycled in an environmentally friendly manner. When you are disposing of our products, please observe the national and local regulations.

Used components must be disposed of exclusively through official collection points via sales centers or your VACUUM PLATE dealer.

Warning



- Do not dispose of rechargeable batteries in household waste, in fire or in water. Do not open used batteries. Do not send defective batteries with damaged housing.

For EU countries only: Under European Directive 2006/66/EC, defective or used batteries must be collected separately and recycled in an environmentally friendly manner.

Note



- Ask your specialist dealer about disposal options.

12. Other applicable documents

- Safety instructions VACUUM PLATE 100-LP
- AMPShare Akku safety instructions
- GAL 18V-40 operating instructions
- AMPShare manufacturer's warranty

13. Declaration of Conformity

Leister Technologies AG, Galileo-Strasse 10, 6056 Kaegiswil, Switzerland confirms that this product fulfills the requirements of the following EU Guidelines in the models that we have made available for purchase:

Directives:	2006/42/EC, 2014/30/EU, 2011/65/EU
Harmonized	EN ISO 12100, EN 60335-1, EN 1012-2,
Standards:	EN 55014-1, EN 55014-2, EN IEC 63000

Kaegiswil, 07/15/2024

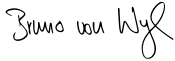

Bruno von Wyl, CTO



Pascal Bösch, VP R&D

Warranty

- The guarantee or warranty rights granted for this device by the direct distribution partner/salesperson apply from the date of purchase. In the event of a guarantee or warranty claim (verification by invoice or delivery note), manufacturing or processing errors will be rectified by the sales partner through replacement delivery or repair.
- Other guarantee or warranty claims are excluded within the framework of mandatory law.
- Damage resulting from natural wear, overload, or improper handling is excluded from the warranty.
- Devices that have been converted or modified by the purchaser are not covered by any warranty or guarantee.
- Only use original Leister spare parts and accessories; otherwise, any warranty or guarantee claims will be invalidated.

↳ Sales and Service Partners



Leister Technologies AG

Galileo-Strasse 10

6056 Kaegiswil

Switzerland

+41 41 662 74 74

leister@leister.com

leister.com